

Catalog & Specification

Premium Water Treatment System



INDOTARA[®]
PT. INDOTARA PERSADA

Jakarta Head Office :
Graha Kencana Building Lt. 10 Suite 10F
Jl. Raya Perjuangan 88
Kebon Jeruk Jakarta Barat 11530
Phone : 021 - 583 55 398
Fax. : 021 - 583 55 400
email : sales@indotara.co.id

Surabaya Branch Office :
Bumi Mandiri Tower I Lt. 10 Suite 1008
Jl. Jend. Basuki Rachmat 129-137
Surabaya 60271
Phone : 031 - 535 3001
Fax. : 031 - 535 3002
email : sales-sby@indotara.co.id

Medan Branch Office :
Kompleks MMTC Warehouse Blok C-7
Jl. Pasar V, Pancing
Medan 20371
Phone : 061 - 800 323 24
Fax. : 061 - 800 322 25
email : sales-mdn@indotara.co.id

Bandung Branch Office :
Wisma HSBC Lt. 6 Suite B
Jl. Asia Afrika No. 116
Bandung, Jawa Barat 40112
Phone : 022 - 426 7333
Fax. : 022 - 426 7330
email : sales-bdg@indotara.co.id



New Products Index



NanoPad
Nanofiltration Water Purifier



Pad2
Compact Tankless RO System



Limpid
RO-100G-T03



UF water filter
UF-T02



Bayonet RO
RO-50G/75G-FF



HIGH FLOW RO SYSTEM
RO-400G-J02



N03F Compact RO
RO-400G-N03F



Nano Jumbo
Nanofiltration Water Purifier



Blue Genius
Reverse Osmosis System



Mr. Cool
HL-3C











TAPURE
TF-05



White Wave
FCV-16-15
FCV-16-20

Index

	Bayonet Cartridge water filters	01
	Compact water filters	17
	Wall-hanging water filters	31
	Traditional water filters	37
	Commercial water filters	44
	Pre-filter	47
	Water Softener	55
	Spare Parts	61



MINI COMPACT DESIGN
The thinnest is only 10.5cm. The combined connector are hidden beside the machine, which is easy and beautiful.

TANK-LESS DESIGN
Easy to use and directly to drink. Enjoy every fresh water in your wonderful life.

NANO PAD
KUSATSU Water filter

PROFESSIONAL NANO FILTRATION
Using professional Nano filtration membrane and three pre-filter cartridge, effectively remove all kinds of impurities and pollutants in water, such as organics, micro organism, virus, metal ions, radioactive ions.

ABS FOOD-GRADE MATERIAL
Compact body, it simple, easy to clean and safety.

SAVING WATER BY EVERY DROP
Every 10L can have 8.5L pure clear water

PROTECTING YOUR DRINKING WATER
The item can show you the lifetime of each cartridge through LED display screen. Protecting your drinking water by changing cartridge time to time.

NanoPad

Nanofiltration Water Purifier

Ultra-thin, Tankless Design, High Recovery rate, High Quality NF Membrane



KUSATSU Brand New NanoPad water filter, 10.5cm thin, the thinnest water filter you could ever imagine. Simple and fashion white compact body with black surface, its beauty and design are beyond all other normal filter.

- High Quality NF Membrane
- High Recovery Rate
- Tankless Design
- On Board Computer
- Ultra-thin Design

TORAY
Nihonbashi Mitsui Tower1-1,
Nihonbashi-Muromachi 2-chrome,
Chuo-ku, Tokyo 103-8666,
JAPAN



Pad 2

Compact Tankless RO System

Features

- » Filter lifespan (PP&CTO&T33): 2000L
- » Pure Water Flow : 1.2L/Min
- » Machine lifespan (PP&CTO&T33): 2000L
- » Four stage Filtration
- » Filtration replacement reminder
- » No tubes or adaptors inside
- » Advanced bayonet cartridge filter
- » Auto shutoff water during filter replacement



The latest card buckle filter
Auto Shut-off



Compact body, Elegant appearance,
Save space effectively

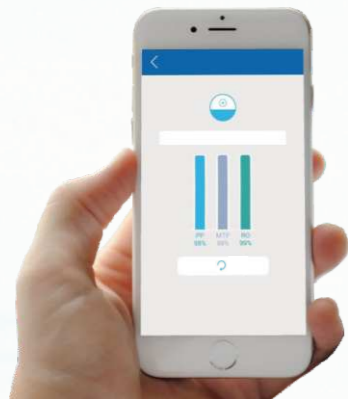

Wifi Controller
Easy Operation



Ultra-low waste water ratio
1/3 less than traditional systems

roPad

Compact Tankless RO System



Features

- » Auto Flush
- » On Board Computer
- » Pure Water Flow : 0.8 ~ 1.2L/Min
- » Luxury Faucet : GF-02C
- » No Tank Needed, Enjoy fresh pure water at any time
- » Machine Dimension : 435x390x105mm
- » Packing Dimension : 475x435x210mm

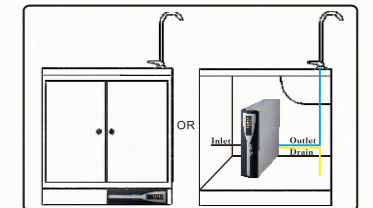

Installation Diagram

Process

- » 1st Stage : PP Sediment Filter
- » 2nd Stage : Carbon Block Filter
- » 3rd Stage : Kusatsu Toray RO Membrane

ufPad

Ultrafiltration Water Purifier



Features

- » On Board Computer
- » Pure Water Flow : 1.8 ~ 2.5L/Min
- » Quick Fitting
- » Luxury Faucet : GF-02C
- » No Tank Needed, Enjoy fresh pure water at any time
- » Machine Dimension : 435x390x105mm
- » Packing Dimension : 475x435x210mm

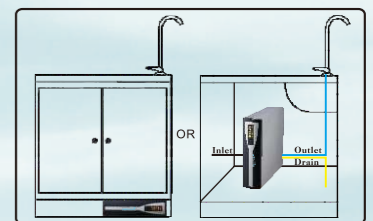

Installation Diagram

Process

- » 1st Stage : PP Sediment Filter
- » 2nd Stage : Carbon Block Filter
- » 3rd Stage : Iodized Resin Filter
- » 4rd Stage : UF Membrane
- » 5th Stage : Activated Carbon



RO-100G-T03



RO-100G-T04



Limpid

RO-100G-T03/T04

- » Pure Water Flow : 450ml/min
- » Raw Water Tank : 5L
- » Pure Water Tank : 2L
- » Three filters : PP CTO RO
- » Size : 440x190x375mm

Features

- » Instant heating
- » Four temperature to adjust
- » 70 seconds Screen shows
- » Filters replacement reminder
- » Working situation display
- » Two sources of raw water
- » Child Lock
- » Output Quantity
- » Shutdown protection when lack water
- » Shutdown Protection when replacing filter
- » Protect pump from "Run Dry"
- » Working Display-water shortage, Purifying, Flushing
- » Output temperature display (Adjustable)
- » Output water regulation (Adjustable)
- » Input water & output water TDS display
- » Filtration lifespan display



Direct drinking UF water filter UF-T02

Features

- » No Need Electricity
- » 4-Stage Filtration With UF
- » Mini Compact Design
- » All Bayonet Cartridges
- » With two doors at both sides
- » Easily replaceable cartridge
- » Packing Dimension : 372x245x410mm



Bayonet Cartridges RO System RO-50G/75G-FF

Features

- » Auto Flush
- » Water output : 50G/75G
- » 5-Stage Filtration With RO
- » With Stable Holding Shelf
- » Bayonet RO Membrane Element
- » Pressure Tank : 3.2G Steel Tank or 3.0G Plastic Tank
- » Packing Dimension : 560x310x440mm



Back View



Max Work Pressure: 20bar

Change filters in seconds, shut off water automaticly. No tools required!



New Design
Date dial-up Plate
Mark the filter replacement time and remind you when to replace the filter again.



CLEAR PURE
Single water filter
KWF-1

Features

- » No Need Electricity
- » Easy Installation
- » Date dial-up Plate
- » Machine Dimension : 90x85x295mm



CLEAR PURE
Double water filter
KWF-2

Features

- » No Need Electricity
- » Easy Installation
- » Date dial-up Plate
- » Machine Dimension : 190x85x295mm



CLEAR PURE
Triple water filter
KWF-3

Features

- » No Need Electricity
- » Easy Installation
- » Date dial-up Plate
- » Machine Dimension : 270x85x295mm



Ultra Pure
KUF-1

Features

- » With Automatic Shutoff Device When Cartridge Replace
- » Change Filter in Seconds without Tools
- » Energy Saving, Environment Protection
- » Attractive new design
- » Small size & Easy Operation
- » Fitting type : Quick Fitting
- » Packing Dimension : 555x345x345mm/ 10pcs



Ultra Pure
KUF-2

Features

- » With Automatic Shutoff Device When Cartridge Replace
- » Change Filter in Seconds without Tools
- » Energy Saving, Environment Protection
- » Attractive new design
- » Small size & Easy Operation
- » High Quality PP & CTO Filter
- » Fitting type : Quick Fitting
- » Packing Dimension : 555x345x345mm/ 10pcs



Ultra Pure
KUF-3

Features

- » With Automatic Shutoff Device When Cartridge Replace
- » Change Filter in Seconds without Tools
- » Energy Saving, Environment Protection
- » Attractive new design
- » Small size & Easy Operation
- » NSF Standard UF Membrane
- » Fitting type : Quick Fitting
- » Packing Dimension : 590x345x380mm/ 5pcs



**Ultra Pure
KUF-4S**

Features

- » With Automatic Shutoff Device When Cartridge Replace
- » Change Filter in Seconds without Tools
- » Energy Saving, Environment Protection
- » Attractive new design
- » Small size & Easy Operation
- » High Quality UF Membrane
- » Fitting type : Quick Fitting
- » Packing Dimension : 380x175x345mm



**Ultra Pure
KUF-4**

Features

- » With Automatic Shutoff Device When Cartridge Replace
- » Change Filter in Seconds without Tools
- » Energy Saving, Environment Protection
- » Attractive new design
- » Small size & Easy Operation
- » High Quality UF Membrane
- » Fitting type : Quick Fitting
- » Machine Dimension : 330x115x330mm
- » Packing Dimension : 380x175x345mm

STELLA

RO-50G/75G-FFE



Features

- » Auto Flush
- » water Output : 50G/ 75G
- » E4-Stage Filtration With RO
- » Dustproof Design
- » Bayonet RO membrane element
- » Pressure Tank : 3.0G Plastic Tank
- » Packing Dimension : 435x210x215mm



- » TDS Display
- » Cartridge Change Reminder



Mini Transformer

RO-50G/75G-R01

Features

- » Bayonet Cartridges
- » On Board Computer
- » UF or RO System for Option
- » With Ultrafiltration & Reverse Osmosis System
- » RO Water Output : 50GPD/75GPD/80GPD/100GPD/125GPD
- » Pressure Tank : 3.2G Steel Tank or 3.0G Plastic Tank
- » Machine Dimension : 370x365x250mm
- » Packing Dimension : 530x430x430mm



Elegant Pure RO System

RO-50G/75G/80G/100G/125G-FFA

Features

- » Bayonet Cartridges
- » TDS & On Board Computer
- » Auto Flush
- » RO Water Output : 50GPD/75GPD/80GPD/100GPD/125GPD
- » Quick Fitting
- » Pressure Tank : 3.2G Steel Tank or 3.0G Plastic Tank
- » Machine Dimension : 400x415x225mm
- » Packing Dimension : 530x430x430mm



4-Stage RO System with Pump

RO-50G/75G/80G/100G/125G-FFB

Features

- » Auto Flush
- » RO Water Output : 50GPD/75GPD/80GPD/100GPD/125GPD
- » Bayonet Cartridges
- » Quick Fitting
- » Pressure Tank : 3.2G Steel Tank or 3.0G Plastic Tank
- » Packing Dimension : 405x295x500mm



4-Stage RO System without Pump

RO-50G/75G/80G/100G/125G-FFC

Features

- » Manual Flush
- » RO Water Output : 50GPD/75GPD/80GPD/100GPD/125GPD
- » Bayonet Cartridges
- » Quick Fitting
- » Pressure Tank : 3.2G Steel Tank or 3.0G Plastic Tank
- » Note : Inlet pressure should be equal to or above 87 psi
- » Packing Dimension : 405x295x500mm



5-Stage RO System without Pump

RO-50G/75G/80G/100G/125G-FFD

Features

- » Manual Flush
- » RO Water Output : 50GPD/75GPD/80GPD/100GPD/125GPD
- » Bayonet Cartridges
- » Quick Fitting
- » Without Pump
- » Pressure Tank : 3.2G Steel Tank or 3.0G Plastic Tank
- » Note : Inlet pressure should be equal to or above 87 psi
- » Packing Dimension : 405x295x500mm



**Tankless
High Flow**

**HIGH FLOW RO SYSTEM
RO-400G-J01**

Features

- » High Flow, Without Tank
- » 3 Stages Filtration : PP, MTP, RO
- » RO Water Output : 400GPD
- » Quick Fitting
- » Big blue bayonet cartridge
- » Change filter in seconds without tools
- » Packing Dimension : 430x240x475mm

Pure Water 1 : 1 Concentrated Water



**Tankless
High Flow**

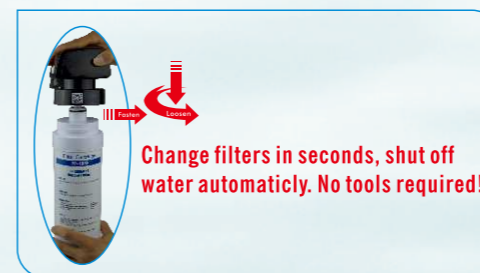

Inside View

**HIGH FLOW RO SYSTEM
RO-400G-J02**

Features

- » High Flow, Without Tank
- » 3 Stages Filtration : PP, MTP, RO
- » RO Water Output : 400GPD
- » Filter Compatible as Everpure
- » Bigblue bayonet cartridge
- » Change filter in seconds without tools
- » Packing Dimension : 395x485x510mm



1/4" Connector



3/8" Connector

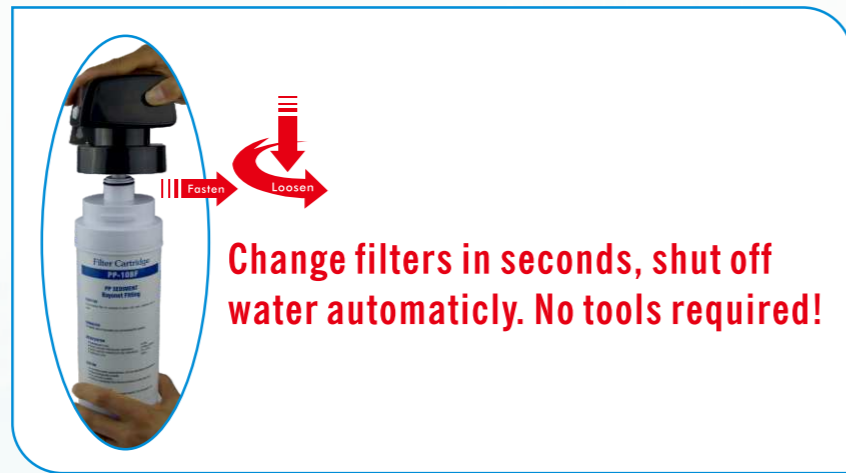

Change filters in seconds, shut off water automatically. No tools required!

MF Water Filter
MTP-10BF

Features

- » Mixing Filter Cartridges
- » Filter Compatible with Everpure
- » Mini Compact design, Big Flow
- » Easily Replacable cartridge
- » Small size & Easy Operation
- » Packing Dimension : 375x470x455mm /6pcs

4-stages filtration : Mixing Filter Cartridges

- » **Calcium sulfite ball :**
Chlorine, Adjust the water PH, make the water weak alkaline
- » **Activated carbon :**
Can effectively remove the peculiar smell, residual chlorine, and absorb the organic matter in water
- » **KDF :**
Is used to treat heavy metal impurity, and bacteria inhibition
- » **UF Membrane :**
Remove the suspended solids, colloid, particles, bacteria



RO-10BF



PP-10BF



GAC-10BF



CTO-10BF



T33-10BF



UF-10BF

Filter compatible as Everpure
Mini Compact design, Big Flow
Easily replaceable cartridge

BIGBLUE Bayonet Cartridge

PP-10BF

- » PP Sediment
- » Packing Dimension : 520x480x455mm/ 16Pcs

BIGBLUE Bayonet Cartridge

GAC-10BF

- » Granular Activated Carbon
- » Packing Dimension : 520x480x455mm/ 16Pcs

BIGBLUE Bayonet Cartridge

CTO-10BF

- » Block Activated Carbon
- » Packing Dimension : 520x480x455mm/ 16Pcs

BIGBLUE Bayonet Cartridge

T33-10BF

- » Inline Activated Carbon
- » Packing Dimension : 520x480x455mm/ 16Pcs

BIGBLUE Bayonet Cartridge

GAC-10BF

- » Ultra Filtration
- » Packing Dimension : 520x480x455mm/ 16Pcs

BIGBLUE Bayonet Cartridge

RO-10BF

- » Reverse Osmosis Filtration
- » Packing Dimension : 520x480x455mm/ 16Pcs

Pure Water 1 : 1 Concentrated Water

Tankless
Direct drinking



10" Filter
Traditional standard filter

PP+GAC+CTO+RO

Compact
Space saving
(390x235x385mm)

High flow
Output:1.2L/Min

Wifi

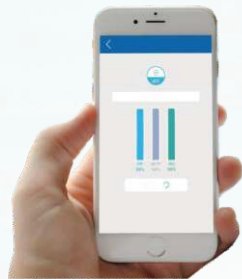

4 color for option

N03F Compact RO
RO- 400G-N03F

Features

- » 4-stage compact RO System : PP, GAC, CTO, RO
- » Pure Water Flow : 1.2L/Min
- » No Tank Needed, Enjoy Fresh Water at Any Time
- » On Board Computer with Cartridge Reminder
- » Lower Waste water ratio : 1:1
- » Smaller but Smarter
- » Wifi Function : Check Working State & TDS at any Time through your phone App
- » Machine Dimension : 390x235x385mm
- » Packing Dimension : 550x285x460mm



Change Filter Easily
N03 Compact RO



5 Stage Filtration
Standard 10" Prefilter

RO-50G/75G/80G/100G/125G-N03

Features

- » 5-stage compact RO System
- » External Adaptor
- » RO Water Output : 50/75/80/100/125GPD
- » Quick Fitting
- » Build-in Tank : 2.5G Smart Tank
- » Packing Dimension : 590x272x460mm



**Build-in Tank
New Design**



InSide View



InSide View

N01 Golden Pure
RO-50G/75G/80G/100G/125G-N01G

Features

- » 4-stage compact RO System
- » TDS & On Board Computer
- » External Adaptor
- » RO Water Output : 50GPD/75GPD/80GPD/100GPD/125GPD
- » Quick Fitting
- » Pressure Tank : 2.0G Steel Tank
- » Packing Dimension : 485x460x295mm



**Build-in Tank
New Design**



Inside View



Inside View

Black Belt Compact RO
RO-50G/75G/80G/100G/125G-N02

Features

- » 5-stage compact RO System
- » TDS & On Board Computer
- » External Adaptor
- » RO Water Output : 50GPD/75GPD/80GPD/100GPD/125GPD
- » Quick Fitting
- » Pressure Tank : 2.0G Smart Tank
- » Machine Dimension : 450x240x400mm
- » Packing Dimension : 500x300x525mm



**Big Flow
Tankless
Nanofiltration**

Nano Jumbo
NF-500G-N02B

Features

- » 5-stage compact Nanofiltration System
- » TDS & On Board Computer
- » External Adaptor
- » NF Water Output : 500GPD
- » Kusatsu Nanofiltration Membrane
- » Machine Dimension : 450x240x400mm
- » Packing Dimension : 500x300x525mm

Blue Genius Compact RO



RO-50G/75G/80G/100G/125G-W01A

Features

- » TDS Display
- » On Board Computer
- » UV Sterilizer for Option
- » RO Water Output : 50GPD/75GPD/80GPD/100GPD/125GPD
- » Quick Fitting
- » Diaphragm Booster Pump With Adaptor 110V/220V, 50/60Hz
- » Pressure Tank : 2.5G Smart Tank
- » Machine Dimension : 450x240x410mm
- » Packing Dimension : 500x300x525mm



RO-50G/75G/80G/100G/125G-W01B

Features

- » Pressure Gauge
- » RO Water Output : 50GPD/75GPD/80GPD/100GPD/125GPD
- » Quick Fitting
- » Diaphragm Booster Pump With Adaptor 110V/220V, 50/60Hz
- » Pressure Tank : 2.5G Smart Tank
- » Machine Dimension : 450x240x410mm
- » Packing Dimension : 500x300x525mm



RO-50G/75G/80G/100G/125G-W01C

Features

- » TDS Display
- » On Board Computer
- » RO Water Output : 50GPD/75GPD/80GPD/100GPD/125GPD
- » Quick Fitting
- » Diaphragm Booster Pump With Adaptor 110V/220V, 50/60Hz
- » Pressure Tank : 3.2G Steel Tank or 3.0G Plastic Tank
- » Machine Dimension : 450x240x410mm
- » Packing Dimension : 500x300x525mm



RO-50G/75G/80G/100G/125G-W01D

Features

- » Compact RO
- » RO Water Output : 50GPD/75GPD/80GPD/100GPD/125GPD
- » Quick Fitting
- » Diaphragm Booster Pump With Adaptor 110V/220V, 50/60Hz
- » Pressure Tank : 2.5G Smart Tank
- » Machine Dimension : 450x240x410mm
- » Packing Dimension : 500x300x525mm



Change filters in seconds, shut off water automatically. No tools required!



With source water tank(11L)
Get free from tap water



Large LED Display Screen

Pipeline Water Filter Dispenser

H01N: With RO System and Source Water Tank

Features

- » With source water tank, you can put this dispenser anywhere you want
- » 3-Stage RO system : PP, CTO, RO
- » Large LED display screen
- » Separate holding tanks
- » Source water tank (11L)
- » Ambient : 5L
- » Hot : 1.8L
- » Cold : 1.8L
- » Cooling by Compressor
- » Children Lock, it can lock the Hot water button
- » Machine Dimension : 36x34x110cm
- » Packing Dimension : 40x42x116cm



RO System or
UF System
In Front Cabinet



RO System or
UF System
In Front Cabinet



Pipeline Water Filter Dispenser

H01A: Water Dispenser only
H01B: With RO System
H01C: With UF System

H02A: Water Dispenser only
H02B: With RO System
H02C: With UF System

Features

- » Water Dispenser
- » Large LED Display Screen
- » Separate Holding Tanks :
Ambient : 5L
Hot : 1.8L
Cold : 1.8L
- » Cooling by Compressor
- » Children lock, it can lock the hot water button
- » Nice Cabinet
- » Machine Dimension : 36x34x110mm
- » Packing Dimension : 40x42x116mm

Features

- » RO System Inside
- » Large LED Display Screen
- » Separate Holding Tanks :
Ambient : 5L
Hot : 1.8L
Cold : 1.8L
- » Cooling by Compressor
- » Children lock, it can lock the hot water button
- » Nice Cabinet
- » Machine Dimension : 36x34x110mm
- » Packing Dimension : 40x42x116mm

Pipeline Water Filter Dispenser

H01W-A: Water Dispenser only
H01W-B: With RO System
H01W-C: With UF System

H03A: Water Dispenser only
H03B: With RO System
H03C: With UF System

Features

- » Ultrafiltration System Inside
- » Large LED Display Screen
- » Separate Holding Tanks :
Ambient : 5L
Hot : 1.8L
Cold : 1.8L
- » Cooling by Compressor
- » Children lock, it can lock the hot water button
- » Nice Cabinet
- » Machine Dimension : 36x34x110mm
- » Packing Dimension : 40x42x116mm

Features

- » Pipeline Water Filter Dispenser
(Can Choose RO System or Ultrafiltration System)
- » Touch Panel
- » Separate Holding Tanks :
Ambient : 5L
Hot : 1.8L
Cold : 1.8L
- » Cooling by Compressor
- » Children lock, it can lock the hot water button
- » Nice Cabinet
- » Machine Dimension : 36x34x110mm
- » Packing Dimension : 40x42x116mm

Mr. Cool



Touch Panel



Large Refrigerated Cabinet



Back View

Mr. Cool(L03A)

Features

- » Pipeline Water Dispenser
- » Separate Holding Tanks
Pure Water : 5L
Hot Water : 1.8L
Cold Water : 1.8L
- » Cooling by Compressor
- » Refrigerated Cabinet
- » Machine Dimension : 40x42x116cm

Mr. Cool



RO System



- ▲ No tap water supply, you can add source water in tank ①.
- ▲ ① Source Water: 2L
- ▲ ② Pure Water: 3L



UF System

Mr. Cool(L03B)

RO

Features

- » Pipeline Water Filter Dispenser (with RO System)
- » Separate Holding Tanks
Hot Water : 1.8L
Cold Water : 1.8L
- » Cooling by Compressor
- » Refrigerated Cabinet
- » Machine Dimension :
500x465x1390mm

Mr. Cool(L03C)

UF

Features

- » Pipeline Water Filter Dispenser (with UF System)
- » Separate Holding Tanks
Hot Water : 1.8L
Cold Water : 1.8L
- » Cooling by Compressor
- » Refrigerated Cabinet
- » Machine Dimension :
500x465x1390mm

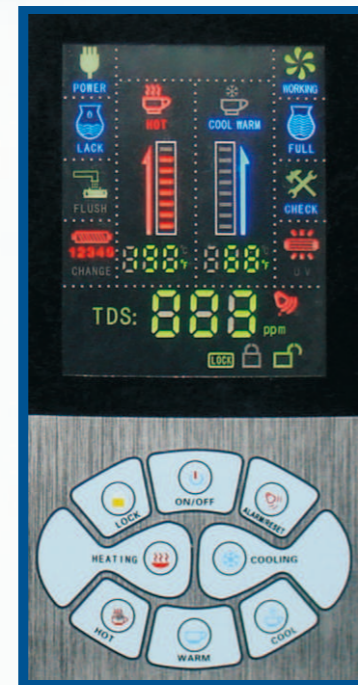

LED Function Display



G01A	G01B	G01C
------	------	------

- Features**
- » Water Dispenser
 - » Large LED Display Screen
 - » Separate Holding Tanks :
Pure Water : 5L
Hot Water : 1.8L
Cold Water : 1.0L
 - » Cooling by PTC
 - » Water Leakage Protection
 - » Water Leak Alarm
 - » Children Lock,
it can lock the watter button
 - » Machine Dimension : 36x34x56cm
 - » Packing Dimension : 39x41x64cm

- Features**
- » RO System Inside
 - » Large LED Display Screen
 - » Separate Holding Tanks :
Ambient : 5L
Hot Water : 1.8L
Cold Water : 1.0L
 - » Cooling by PTC
 - » Water Leakage Protection
 - » Water Leak Alarm
 - » Children Lock,
it can lock the watter button
 - » Machine Dimension : 36x34x56cm
 - » Packing Dimension : 39x41x64cm

- Features**
- » Ultrafiltration System Inside
 - » Large LED Display Screen
 - » Separate Holding Tanks :
Ambient : 5L
Hot Water : 1.8L
Cold Water : 1.0L
 - » Cooling by PTC
 - » Water Leakage Protection
 - » Water Leak Alarm
 - » Children Lock,
it can lock the watter button
 - » Machine Dimension : 36x34x56cm
 - » Packing Dimension : 39x41x64cm

Luxury Stainless Steel Water Dispenser with Purifier
RO
RO-200G/300G/400G-L01

- Features**
- » With IC Controller
 - » LCD Screen Accurately Display Hot & Cold Water
 - » Fitting Type : Quick Fitting
 - » Electricity Leakage Protection
 - » Heating by EGO
 - » With Hot, Pure, Cool Water
Hot Water Tank : 5L
Pure Water Tank : 25L
Cool Water Tank : 3L
 - » Water Output : 200GPD/300GPD/400GPD
 - » Machine Dimension : 50x58x150cm

Luxury Stainless Steel Water Dispenser with Purifier
RO
RO-200G/300G/400G-L02

- Features**
- » With IC Controller
 - » LCD Screen Accurately Display Hot & Cold Water
 - » Fitting Type : Quick Fitting
 - » Electricity Leakage Protection
 - » Heating by EGO
 - » With Hot, Pure, Cool Water
Hot Water Tank : 5L
Pure Water Tank : 25L
Cool Water Tank : 3L
 - » Water Output : 200GPD/300GPD/400GPD
 - » Machine Dimension : 50x58x150cm

Mr. Cool



Intelligent control water temperature real-time monitoring



Quick Fitting Filter Cartridges



- HL-3A**
- » Room-temperature, Hot Water
 - » Rated Power : 3000W
 - » Heating Power : 3000W
 - » Hot : 20L
 - » Rated Voltage : 220V
 - » Rated Frequency : 50Hz/60Hz
 - » Machine Dimension : 40x38x132cm

- HL-3B**
- » Room-temperature, Hot Water
 - » Rated Power : 3000W
 - » Heating Power : 3000W
 - » Hot : 20L
 - » Rated Voltage : 220V
 - » Rated Frequency : 50Hz/60Hz
 - » Machine Dimension : 48x43x160cm

- HL-3C**
- » Room-temperature, Hot Water
 - » Rated Power : 1200W
 - » Heating Power : 900W
 - » Cooling Power : 110W
 - » Hot : 5L
 - » Cold : 5L
 - » Rated Voltage : 220V
 - » Rated Frequency : 50Hz/60Hz
 - » Machine Dimension : 40x38x132cm

DRINKING WATER BOILER



Model	HZ-40K (Single faucet)	HZ-60K	HZ-90K	HZ-120K
Water Volume	15L	15L	32L	32L
Supplying hot water	40L/H	60L/H	90L/H	120L/H
Power Supply	3000W	6000W	9000W	12000W
Voltage	220V~50Hz	380V~50Hz	380V~50Hz	380V~50Hz
Packing Dimension (L x W x H (cm))	40x48x124	40x48x124	50x48x132	50x50x137

- Features**
- » Instant Use
 - » Intelligent Control
 - » Saving Energy and Protecting Environment
 - » Automatic temperature stabilization technology

WHITE BOX RO System



RO-50G/75G/80G/100G/125G-H09

Features

- » Small Size & Easy Operation
- » Attractive New Design
- » Auto Flush
- » RO Water Output :
50GPD/75GPD/80GPD/100GPD/125GPD
- » Diaphragm Booster Pump
with Adaptor 110V/220V, 50/60Hz
- » Quick Fitting
- » Pressure Tank : 3.2G Steel Tank or 3.0G Plastic Tank
- » Machine Dimension : 310x155x480mm
- » Packing Dimension : 355x185x560mm



HEALTH MANAGER

RO-50G/75G/80G/100G/125G-H08

Features

- » Small Size & Easy Operation
- » Attractive New Design
- » Auto Flush
- » RO Water Output : 50GPD/75GPD/80GPD/100GPD/125GPD
- » Diaphragm Booster Pump with Adaptor 110V/220V, 50/60Hz
- » Quick Fitting
- » Pressure Tank : 3.2G Steel Tank or 3.0G Plastic Tank
- » Machine Dimension : 335x145x430mm
- » Packing Dimension : 445x440x350mm

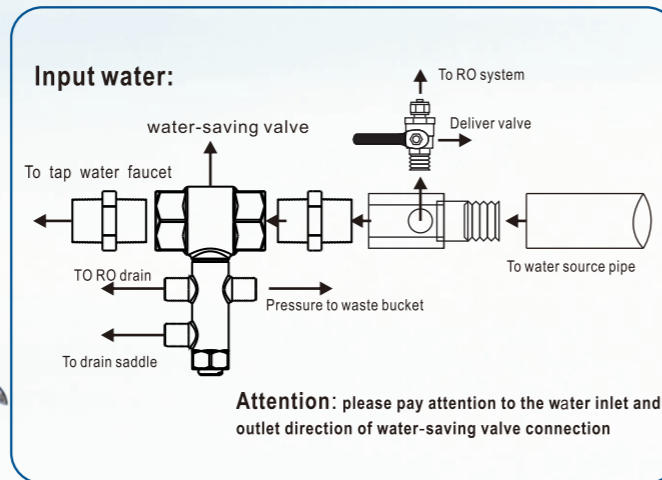

NO WASTE RO SYSTEM

RO-50G/75G/80G/100G/125G-H08W

Features

- » Auto Flush
- » No Waste Water
- » RO Water Output :
50GPD/75GPD/80GPD/100GPD/125GPD
- » Fast-Fit Cartridges : PP, GAC, CTO, T-33
- » Special Pressure Tank and Valve
- » Packing Dimension : 340x95x440mm

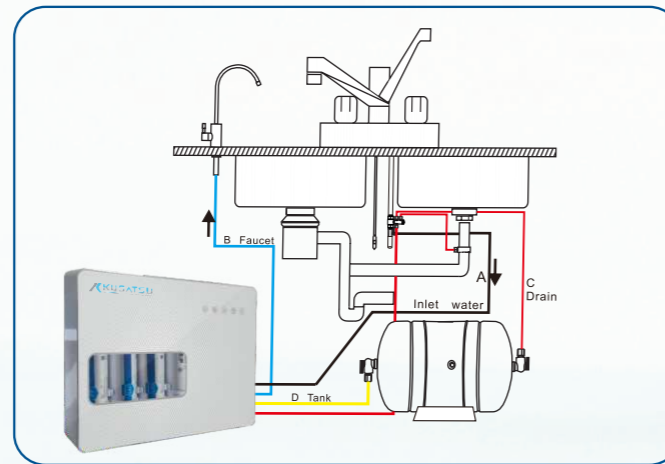

ULTRAFILTRATION SYSTEM

H08UF

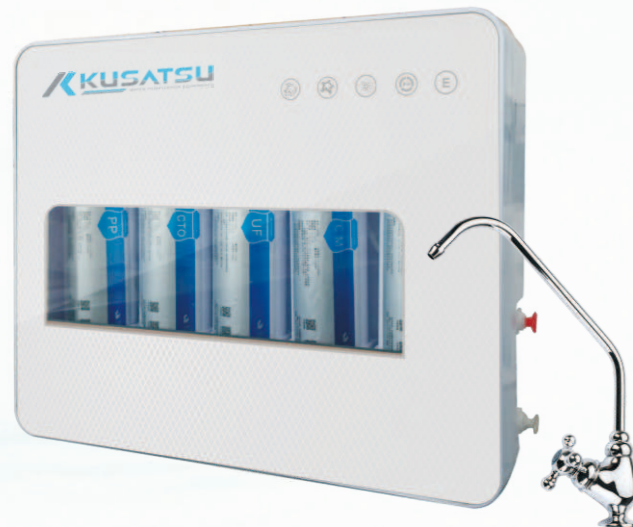

Features

- » Small Size & Easy Operation
- » Attractive New Design
- » High Quality UF Membrane
- » Energy Saving, Environment Protection
- » Fitting Type : Quick Fitting
- » Machine Dimension : 415x90x335mm
- » Packing Dimension : 340x95x440mm

RO-50G/75G/80G/100G-H07

Features

- » 5-stage RO System : PP, GAC, CTO, RO, T33
- » On Board Computer
- » Dustproof design
- » RO water Output :
50G/75G/80G/100GPD
- » Diaphragm Booster Pump
With adaptor 110V/220V, 50/60Hz
- » 3.0G Plastic tank or 3.2G Steel Tank for Option
- » Water Leakage Protection
- » Two Colors for Option
- » Packing Dimension : 515x465x610mm



Build-in Pipeline Water Dispenser



H05

Features

- » Hot & Warm Water
- » Directly Pipeline Water Dispenser, Avoid Secondary Pollution
- » Light Indicator
- » Suitable for Family, Office Use
- » Attractive Design, Small Size & Easy Operation
- » Packing Dimension : 35.5x18x48cm



H06

Features

- » Hot & Warm Water
- » Directly Pipeline Water Dispenser, Avoid Secondary Pollution
- » Light Indicator
- » Suitable for Family, Office Use
- » Attractive Design, Small Size & Easy Operation
- » Packing Dimension : 32x19x44cm



H19

Features

- » Instant Heating Pipeline Water Dispenser
- » No Hot Tank : Drinking Upon Heating
- » Instant Heating Technology
- » Food Grade Water Supply
- » Temperature Indicating
- » Intelligent Temperature Control
- » Overheating Protection
- » Touch Panel
- » Quantitive Water
- » Packing Dimension : 35.5x18.5x47cm



H18

Features

- » Safety : Electricity & Water Separated
- » Health : Drinking Upon Heating
- » Energy Conversation : Vacum Heat Preservation
- » Convenience : Big Flow Rate, Intelligent Control
- » Packing Dimension : 35x45x11.6mm

RO-50G/75G/80G/100G-T01

Features

- » 4-Stage RO System : PP, GAC, RO, T33
- » No Tank Needed, Enjoy fresh water instantly
- » Children lock function protect children from hot water
- » RO water output : 50G/75G/80G/100G
- » Ambient : 4.5L
- » Hot : 1.5L
- » Packing Dimension : 675x270x480mm

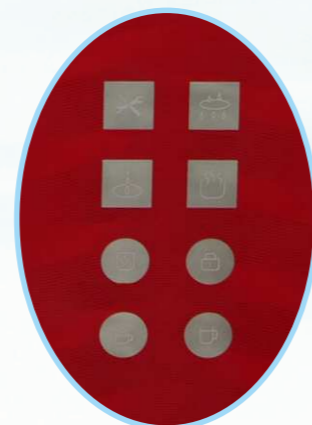

Smart touch buttons

SMART PURE



RO-50G/75G/80G/100G/125G-Y01

Features

- » OnBoard Computer
- » Dustproof of Design
- » Cartridges Change Reminder
- » RO Water Output : 50GPD/75GPD/80GPD/100GPD/125GPD
- » Quick Fitting
- » Diaphragm Booster Pump With Adaptor 110V/220V, 50/60Hz
- » Pressure Tank : 3.2G Steel Tank or 3.0G Plastic Tank
- » Machine Dimension : 390x210x490mm
- » Packing Dimension : 440x360x580mm



WORKING LACK FULL FLUSH CHECK

5-Stage Filtration
Cartridges Change Reminder

SMART PURE



RO-50G/75G/80G/100G/125G-Y02

Features

- » OnBoard Computer
- » Dustproof of Design
- » Cartridges Change Reminder
- » RO Water Output : 50GPD/75GPD/80GPD/100GPD/125GPD
- » Quick Fitting
- » Diaphragm Booster Pump With Adaptor 110V/220V, 50/60Hz
- » Pressure Tank : 3.2G Steel Tank or 3.0G Plastic Tank
- » Machine Dimension : 390x210x490mm
- » Packing Dimension : 440x360x580mm



5-Stage Filtration

Residential RO System



Blue Dream

RO-50G/75G/80G/100G/125G-X01

Features

- » Auto Shutoff Float Switch
- » Compact & Elegant
- » RO water Output :
50GPD/75GPD/80GPD/100GPD/125GPD
- » Quick Fitting inline Cartridge
- » Diaphragm Booster Pump
with Adapter 110/220V, 50/60Hz
- » Built in Water Tank 7.0 Liter
- » Counter Top Application
- » Machine Dimension : 350x315x535cm
- » Packing Dimension : 315x385x570cm



Blue Star

RO-50G/75G/80G/100G/125G-X02

Features

- » Auto Shutoff Float Switch
- » Compact & Elegant
- » RO water Output :
50GPD/75GPD/80GPD/100GPD/125GPD
- » Quick Fitting inline Cartridge
- » Diaphragm Booster Pump
with Adapter 110/220V, 50/60Hz
- » Built in Water Tank 5.8 Liter
- » Counter Top Application
- » Packing Dimension : 375x290x520cm

Blue Tide RO System



RO-200G/400G/600G-P01

Features

- » High Flow, without Tank
- » RO Water Output :
200GPD/400GPD/600GPD
- » Quick Fitting
- » Machine Dimension : 400x220x480mm
- » Packing Dimension : 420x415x465cm

Blue Wave RO System



RO-50G/75G/80G/100G/125G-D02

Features

- » Manual Flush
- » RO Water Output :
50GPD/75GPD/80GPD/100GPD/125GPD
- » Quick Fitting
- » Diaphragm Booster Pump
with Adaptor 110V/220V, 50/60Hz
- » Pressure Tank : 3.2G Steel Tank
or 3.0G Plastic Tank
- » Machine Dimension : 400x220x480mm
- » Packing Dimension : 520x400x470mm

Crescent RO System



RO-400G-Y03

Features

- » 5-stage RO System :
PP, GAC, CTO, RO, T33
- » Pure Water Flow : 1.2L/min
- » No Tank Needed, Enjoy Fresh
Water Instantly
- » On Board Computer
- » Lower Waste Water Ratio : 1:1
- » Packing Dimension :
400x280x530mm



Inside View (Back)



Inside View (Back)



Standard 5-Stage RO System with Pump

RO-50G/75G/80G/100G/125G-A01

Features

- » Manual Flush
- » RO Water Output : 50GPD/75GPD/80GPD/100GPD/125GPD
- » Housing : 122-10Y-W Single "O" Ring Housing
- » Quick Fitting
- » Diaphragm Booster Pump With Adaptor 110V/220V, 50/60Hz
- » Pressure Tank : 3.2G Steel Tank or 3.0G Plastic Tank
- » Machine Dimension : 360x145x440mm
- » Packing Dimension : 440x360x580mm



5-Stage RO System without Pump

RO-50G/75G/80G/100G/125G-E01

Features

- » Manual Flush
- » RO Water Output : 50GPD/75GPD/80GPD/100GPD/125GPD
- » Housing : 122-10Y-W Single "O" Ring Housing
- » Quick Fitting
- » Without Pump
- » Pressure Tank : 3.2G Steel Tank or 3.0G Plastic Tank
- » Note : Inlet Pressure should be Equal to above 87 psi
- » Packing Dimension : 420x290x560mm



6-Stage RO System with Medicinal Stone

RO-50G/75G/80G/100G/125G-A02

Features

- » 6th Stage : Medicinal Stone
- » Manual Flush
- » RO Water Output : 50GPD/75GPD/80GPD/100GPD/125GPD
- » Housing : 122-10Y-W Single "O" Ring Housing
- » Quick Fitting
- » Diaphragm Booster Pump With Adaptor 110V/220V, 50/60Hz
- » Pressure Tank : 3.2G Steel Tank or 3.0G Plastic Tank
- » Machine Dimension : 360x145x440mm
- » Packing Dimension : 440x360x580mm



Aquarium RO System

RO-100G-AQ

Features

- » Auto Flush
- » On Board Computer :
- » First Stage : PP Filter, removes sediments and large particles
- » Second Stage : Activated Carbon Filter, Removes Chlorine and odor
- » Third Stage : RO Membrane, removes bacteria, Heavy metals, dissolved matter, and salinity
- » Forth Stage : Resin Cartridge, removes calcium and Magnesium ions to generate soft water
- » Packing Dimension : 430x370x580mm



6-Stage RO System with UV

RO-50G/75G/80G/100G/125G-A03

Features

- » 6th Stage : Ultraviolet water sterilizer
- » Manual Flush
- » RO Water Output : 50GPD/75GPD/80GPD/100GPD/125GPD
- » Housing : 122-10Y-W Single "O" Ring Housing
- » Quick Fitting
- » Diaphragm Booster Pump With Adaptor 110V/220V, 50/60Hz
- » Pressure Tank : 3.2G Steel Tank or 3.0G Plastic Tank
- » Machine Dimension : 360x145x440mm
- » Packing Dimension : 440x360x580mm



3-Stage RO System without Pump

RO-50G/75G/80G/100G/125G-F01

Features

- » RO Water Output : 50GPD/75GPD/80GPD/100GPD/125GPD
- » Housing : 122-10Y-W Single "O" Ring Housing
- » Quick Fitting
- » Without Pump
- » Pressure Tank : 3.2G Steel Tank or 3.0G Plastic Tank
- » Note : Inlet Pressure Should be Equal to or Above 87 psi
- » Packing Dimension : 430x370x580mm



TDS Display RO System

RO-50G/75G/80G/100G/125G-C01

Features

- » TDS & On Board Computer
- » RO Water Output : 50GPD/75GPD/80GPD/100GPD/125GPD
- » Housing : 122-10Y-W Single "O" Ring Housing
- » Quick Fitting
- » Diaphragm Booster Pump With Adaptor 110V/220V, 50/60Hz
- » Pressure Tank : 3.2G Steel Tank or 3.0G Plastic Tank
- » Machine Dimension : 360x145x440mm
- » Packing Dimension : 440x360x580mm



RO Demo Kits

RO demo kits mainly contains the following items:

Process 5 Stage Filtration	
» BP-01	Booster Pump (50G) x1
» QAD-01	Adaptor (50G) x1
» PP-33	PP spun fiber filter x1
» GAC-33	Granular carbon filter x1
» CTO-33	Block carbon filter x1
» T-33	Activated carbon filter x1
» T-300	Flow-limit valve x1
» Kusatsu or Filmtec	RO Membrane (50G) x1
» GF-02C	Goose faucet x1
» TR-420-1	Water electrolyzer x1
» TDS-1	TDS Meter x1



De-Ionisation RO System

RO/DI

Process
» 1st Stage : PP Filter removes sediment and large particles
» 2nd Stage : RO Membrane removes bacteria, Heavy metals, Dissolved matter, and salinity
» 3rd Stage : Resin removes residual traces of pesticides and hydrocarbon contaminates
» Faucet : GF-01
» Packing Dimension : 420x350x580mm



Compact 3-Stage RO System

RO-50G-3

Process
» 1st Stage : PP Filter removes sediment and large particles
» 2nd Stage : Activated Carbon Filter Removes Chlorine and odor
» 3rd Stage : RO Membrane removes bacteria, Heavy metals, Dissolved matter, and salinity
» Packing Dimension : 37x22.5x13cm



Luxury Steel Box RO System with Tank Inside

RO-100G/200G/400G/600G/800G-B08

Features

- » On Board Computer
- » Auto Flush
- » Pressure Gauge
- » Housing : 122-20 Single "O" Ring Housing
- » RO Water Output :
100GPD/200GPD/400GPD/600GPD/800GPD
- » Fitting Type : JACO
- » Diaphragm Booster Pump
with Adaptor 110V/220V, 50/60Hz
- » Pressure Tank : 11G Steel Tank
- » Packing Dimension : 60x60x155cm



Dispenser Holding Tank

DPT-001
» RO Water Holding
» Tank for water Dispenser
» Capacity : 4L
» Packing Dimension : 405x405x410mm /8pcs



Dispenser Holding Tank

DPT-002
» RO Water Holding
» Tank for water Dispenser
» Capacity : 8L
» Packing Dimension : 540x530x450mm /8pcs



Colour Box

Use the Dispenser Holding Tank to reduce Cost and Enjoy Pure RO water from the Convenience of your water cooler

Connect to RO system



Usage

- » Remove water bottle and Holder
- » Install Dispenser Holding Tank
- » Connect Tank to RO unit



Luxury Steel Box RO System with IC Controller

RO-100G/200G/400G/600G/800G-B07

Features

- » On Board Computer
- » Auto Flush
- » Pressure Gauge
- » Housing : 122-20 Single "O" Ring Housing
- » RO Water Output :
100GPD/200GPD/400GPD/600GPD/800GPD
- » Fitting Type : JACO
- » Diaphragm Booster Pump
with Adaptor 110V/220V, 50/60Hz
- » Pressure Tank : 11G Steel Tank
- » Packing Dimension : 61x61x100cm

Steel Box 5-Stage RO System
RO-200G/400G-B06



Features

- » On Board Computer
- » Auto Flush
- » Pressure Gauge
- » Housing : 122-20 Single "O" Ring Housing
- » RO Water Output : 200GPD/400G GPD
- » Fitting type : JACO
- » Diaphragm Booster Pump with Adaptor 110V/220V, 50/60Hz
- » Pressure Tank : 11G Steel Tank
- » Packing Dimension : 59x42x99cm

Commercial RO System

Luxury Steel Box RO System
RO-100G/200G/400G/600G-B11



Features

- » On Board Computer
- » Auto Flush
- » Pressure Gauge
- » Housing : 122-20 Single "O" Ring Housing
- » RO Water Output : 100GPD/200GPD/400GPD/600GPD/800GPD
- » Fitting type : JACO
- » Diaphragm Booster Pump with Adaptor 110V/220V, 50/60Hz
- » Pressure Tank : 11G Steel Tank
- » Packing Dimension : 53x44x106cm

5-Stage RO System with Steel Shelf
RO-200G/400G/600G-D02B



Features

- » Flush type : Manual Flush
- » With steel shelf
- » Housing : 122-20 Single "O" Ring Housing
- » RO Water Output : 200GPD/400G GPD
- » Fitting type : JACO
- » Diaphragm Booster Pump with Adaptor 110V/220V, 50/60Hz
- » Pressure Tank : 11G Steel Tank
- » Packing Dimension : 45.5x29x80cm

Luxury Steel Box RO System with Tank Inside
RO-100G/200G/400G/600G/800G-B12



Features

- » On Board Computer
- » Auto Flush
- » Pressure Gauge
- » Housing : 122-20 Single "O" Ring Housing
- » RO Water Output : 100GPD/200GPD/400GPD/600GPD/800GPD
- » Fitting type : JACO
- » Diaphragm Booster Pump with Adaptor 110V/220V, 50/60Hz
- » Pressure Tank : 11G Steel Tank
- » Packing Dimension : 53x63x126cm

5-Stage RO System with Steel Shelf
RO-200G/400G-D01



Features

- » Flush type : Manual Flush
- » With steel shelf
- » Housing : 122-20 Single "O" Ring Housing
- » RO Water Output : 200GPD/400G GPD
- » Fitting type : JACO
- » Diaphragm Booster Pump with Adaptor 110V/220V, 50/60Hz
- » Pressure Tank : 11G Steel Tank
- » Packing Dimension : 47x31x88cm



TAPURE

Model: TF-04

Features

- » Three levels protection, no leakage
- » Variety of faucet converters, meet different models of faucets
- » Energy Saving, Environment Protecting
- » Quick Fitting
- » Packing Dimension : 11x5.5cm



TAPURE

Model: TF-05

Features

- » Hybrid Filter Element
- » Filtration Precision is about 0.01 Micron
- » Bacterial removes rates can reach up of 99.99%
- » Cleaner, Healthier, Tastier
- » Packing Dimension : 305x215x78mm

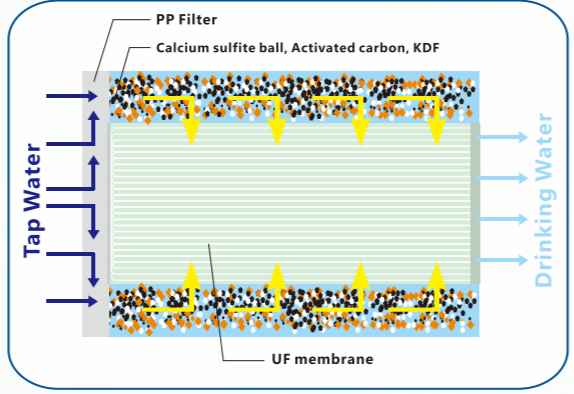

- » **Calcium Sulfite Ball** : remove the residual chlorine, Adjust the water PH, make the water weak alkaline
- » **Activated Carbon** : can effectively remove the peculiar smell, residual chlorine, absorb the organic matter in water
- » **KDF** : is used to treat heavy metal impurity, and bacteria inhibition
- » **UF Membrane** : remove the suspended solids, colloid, particles, bacteria

HOW TO USE

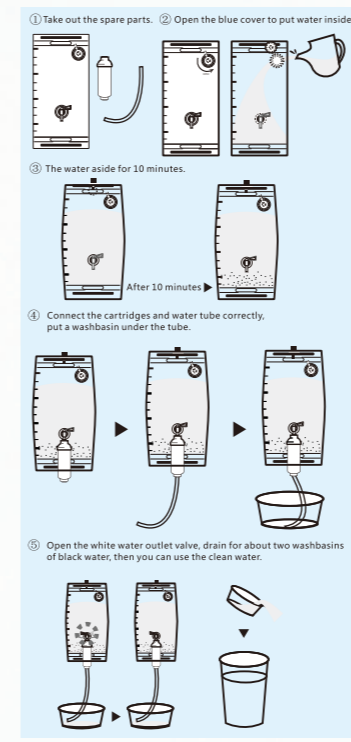

WPB-01

Features

- » Multi-Fuction Cartridge, Drinking Directly
- » PP, Iodized Resin, Coconut Carbon, UF Membrane
- » Pocketable, Easy Operation
- » No Need Electricity
- » Bag Capacity : 10L
- » Service life : 500L
- » Packing Dimension : 350x140x75mm

Filter Cartridge

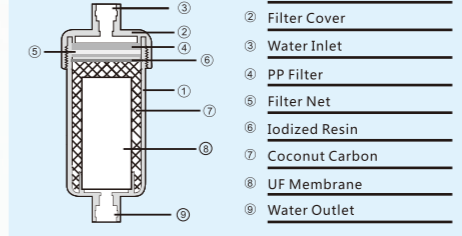

- ① Filter Housing
- ② Filter Cover
- ③ Water Inlet
- ④ PP Filter
- ⑤ Filter Net
- ⑥ Iodized Resin
- ⑦ Coconut Carbon
- ⑧ UF Membrane
- ⑨ Water Outlet

Emergency Water Purifying Bag



JS-01

Water Pitcher

- » Pure Water Flow : 200-250ml/min
- » Cleaner, Healthier, Tastier
- » Easily Replaceable Reminder
- » Cartridge Replacement Reminder
- » Pitcher Capacity : 2.5L
- » Packing Dimension : 225x125x250mm



JS-02

Water Pitcher

- » Pure Water Flow : 200-250ml/min
- » Cleaner, Healthier, Tastier
- » Easily Replaceable Reminder
- » Cartridge Replacement Reminder
- » Pitcher Capacity : 3.0L
- » Packing Dimension : 300x170x280mm



JS-03

Water Pitcher

- » Pure Water Flow : 200-250ml/min
- » Cleaner, Healthier, Tastier
- » Easily Replaceable Reminder
- » Cartridge Replacement Reminder
- » Pitcher Capacity : 2.8L
- » Packing Dimension : 280x130x300mm



SPARKLING

Features

- » Adopt the Environmental Material in conformity with Food Grade standard
- » Light bottle design with screw type, easy to twist from the device and more Convenient for every use
- » Only three-second production time enables sparkling water much more tasty

Intelligent Filter Cartridge

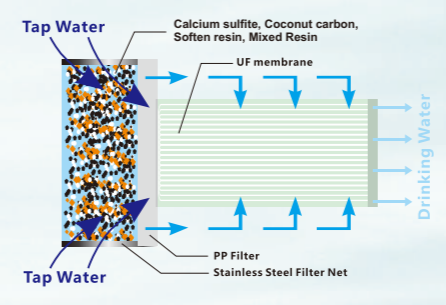

- » **Calcium Sulfite Ball** : remove the residual chlorine, Adjust the water PH, make the water weak alkaline
- » **Coconut Carbon** : can effectively remove the peculiar smell, residual chlorine, absorb the organic matter in water
- » **Soften Resin** : Reduce the hardness of water, improve the water taste
- » **Mixed Resin** : Remove the heavy metals in water, can reduce TDS value of tap water, improve water purity
- » **UF Membrane** : remove the suspended solids, colloid, particles, bacteria and other harmful substances in the water

Mineral Water Pot



MWF-1402

Capacity : 14L
Packing Dimension : 29x29x26cm

Ceramic Filter

The Ceramic Filter is made from a highly compressed ceramic diatomic substance it is highly resistant to heat as tested by professionals
The Ceramic Filter diameter is 0.2 micron (diameter of bacteria 0.5-1.0 micron)
The Function is to filter all dirt, sand, particles and bacteria to ensure that your water is free from any harmful diseases such as typhoid, cholera and dysentery

Multi-Stage Filter

This is the most advanced and efficient filter ever designed recently in the world It needs only one filter to remove impurities such as bacteria, contaminants, chemical, heavy metals etc, and yet retains all the good minerals and nutrients in the water
The filter provides you with clean and clear water, without unpleasant, taste or obnoxious odor patented high technology, it blend 19 natural raw materials into one, at high pressure and temperature

Mineral Stone

This andesite contains various nourishing minerals such as potassium, sodium, calcium, and magnesium and other micro elements which are essential for good health

Magnetic Water Tap

The earth's magnetic field generally promotes vitality for the human body. To Exploit this essence, the outlet tap of water system is fitted with magnetic inline with the latest water technology Magnetized water has free moving hexagonal structured water molecules in harmony with body fluids Just like mineral spring water, it promotes health and vitality, and imparts many therapeutic properties



UF-Plus Water Purifier WP-2

Process

- » 1st Stage : PP-10 PP Spun Fiber filter
- » 2nd Stage : GAC-10 Granular Carbon Filter
- » 3rd Stage : CTO-10 Block Carbon Filter
- » 4th Stage : UF-10C Ultra Filter Membrane
- » 5th Stage : T-33 Activated Carbon
- » Packing Dimension : 400x170x450mm

Water Filters



Single Filter

SST-1

10" Disposable Cartridge
(PP 1u, PP 5u, GAC, or CTO Available)
Packing Dimension : 370x470x570mm /12pcs



Double Filter

SST-2

10" Disposable Cartridge - PP 5u + CTO
(PP 1u and GAC Available)
Packing Dimension : 560x380x370mm /6pcs



Triple Filter

SST-3

10" Disposable Cartridge
PP 5u + GAC + CTO (PP 1u Available)
Packing Dimension : 430x800x370mm /6pcs

Water Filters



Single Filter

NT-1W

10" Disposable Cartridge
(PP 1u, PP 5u, GAC, or CTO Available)
Packing Dimension : 500x300x360mm /8pcs



Double Filter

NT-2W

10" Disposable Cartridge - PP 5u + CTO
(PP 1u and GAC Available)
Packing Dimension : 590x310x350mm /4pcs



Triple Filter

NT-3W

10" Disposable Cartridge
PP 5u + GAC + CTO (PP 1u Available)
Packing Dimension : 580x430x360mm /4pcs



Single Filter

NT-1

10" Disposable Cartridge
(PP 1u, PP 5u, GAC, or CTO Available)
Packing Dimension : 140x140x340mm



Double Filter

NT-2

10" Disposable Cartridge - PP 5u + CTO
(PP 1u and GAC Available)
Packing Dimension : 290x145x340mm



Triple Filter

NT-3

10" Disposable Cartridge
PP 5u + GAC + CTO (PP 1u Available)
Packing Dimension : 420x140x340mm



Single Filter

NW-1

10" Disposable Cartridge
(PP 1u, PP 5u, GAC, or CTO Available)
Packing Dimension : 208x145x360mm



Double Filter

NW-2

10" Disposable Cartridge - PP 5u + CTO
(PP 1u and GAC Available)
Packing Dimension : 345x145x360mm



Triple Filter

NW-3

10" Disposable Cartridge
PP 5u + GAC + CTO (PP 1u Available)
Packing Dimension : 450x145x360mm

Water Filters



Single Filter

US-1

10" Disposable Cartridge
(PP 1u, PP 5u, GAC, or CTO Available)
Packing Dimension : 170x140x350mm



Double Filter

US-2

10" Disposable Cartridge - PP 5u + CTO
(PP 1u and GAC Available)
Packing Dimension : 295x140x350mm



Triple Filter

US-3

10" Disposable Cartridge - PP 5u + CTO
PP 5u + GAC + CTO (PP 1u Available)
Packing Dimension : 410x140x350mm



Four Stage Filter

US-4

US-3+T331 (Iodized Resin) or UV-6
Packing Dimension : 570x425x385mm /4pcs



Five Stage Filter

US-5

US-3+T-33 (Activated Carbon)+T331 (Iodized Resin) or UV-6
US-3+UF Membrane + T331 (Iodized Resin)
Packing Dimension : 580x420x370mm /4pcs



Water Filter

WF-10B2

10" Big Blue Cartridge (PP + CTO)
Packing Dimension :
210x200x430mm



Water Filter

WF-10B3

10" Big Blue Cartridge :
(5umPP + CTO + 1umPP)
Packing Dimension :
210x200x430mm



Water Filter

WF-20B2

20" Big Blue Cartridge (PP + CTO)
Packing Dimension :
405x230x825mm



Water Filter

WF-20B3

20" Big Blue Cartridge
(5umPP + CTO + 1umPP)
Packing Dimension :
600x230x825mm



Shower Head

Item No. : SFH-01

Filter Media

- » Calcium Sulfite & Vitamin C Balls
- » Negative Ion Balls
- » Germanium Balls
- » Packing Dimension : 540x440x310cm /25pcs

Benefit

- » Eliminates Chlorine in water supply to keep skin and hair healthy
- » Vitamin C is released during the showering promoting healthier skin
- » Far infrared is released to improve water dissolving and cleaning properties

Usage

- » Ensure hose is the correct size for new shower head before proceeding with installation
- » Remove old shower head and connect new shower head to hose
- » Recommended filter replacement interval is 3-6 months depending on usage



Shower Filters



Shower Filter



SF-02

Calcium Sulfite, KDF, Magnet
Activated Ceramic Ball
Packing Dimension :
420x420x370cm /50pcs



SF-02G

Calcium Sulfite, KDF, Magnet
Activated Ceramic Ball
Packing Dimension :
420x420x370cm /50pcs



SF-01

Coconut Carbon, KDF
Packing Dimension :
420x420x370cm /50pcs



SF-01G

Coconut Carbon, KDF
Packing Dimension :
420x420x370cm /50pcs



Pre-Filter



Filtration & Function

- » Remove sand, Silt, and Rust Particles in water
- » Solve the problem of secondary pollution in the distribution of city water pipeline network and turbidity of water in rural ground water

Siliphos Cartridges for Option

- » Prevents "brown" or "red" water and Clogged pipes, keeps pipe work clean

Parameter

Model No.	PRF-01
Water Source	City Water
Suitable pressure	1 bar ~ 8 bar
Water Flow	1000 L/H
Water Inlet	½ inch
Purified water output	½ inch
Drain Outfall	½ inch
Filtration precision	40~90 μm
Rating temp	5~45°C
Packing Dimension	215 x 115 x 100 mm

Features

- » High Filtration Precision
- » Excellent Performance
- » Simple Structure
- » Easy Operation

Installation Diagram

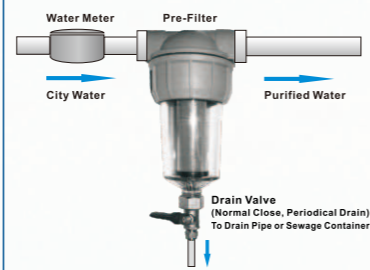

STEEL FOUNTAIN



KDF

Activated Carbon

UF Membrane



Filtration & Function

- » Remove sand, Silt, and Rust Particles in water
- » Solve the problem of secondary pollution in the distribution of city water pipeline network and turbidity of water in rural ground water

Parameter

Model No.	PRF-02
Water Source	City Water
Suitable pressure	1 bar ~ 8 bar
Water Flow	V = 2.6m ³ /h (P ² =0.2 bar) V = 4.2m ³ /h (P ² =0.5 bar)
Water Inlet	½, ¾, 1 inch (DN20-25)
Purified water output	½, ¾, 1 inch (DN20-25)
Drain Outfall	½ inch
Filtration precision	40~90 μm
Rating temp	5~45°C
Packing Dimension	240 x 140 x 90 mm

Features

- » High Filtration Precision
- » Excellent Performance
- » Simple Structure
- » Easy Operation

Installation Diagram

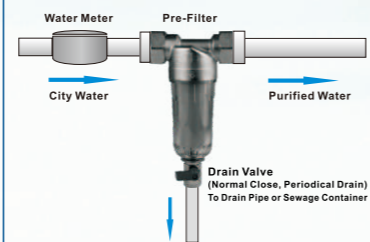

Three Stage Filtration, Direct Drinking Water

Model No. : UF-1000

Suitable temperature : 5~45°C

Water Output : 1000L /H

Packing dimension : 505x175x175 mm

White Wave



FCV-16-15

- » Raw Water : Municipal Tap water
- » Working Pressure : 0.15 - 0.5 Mpa
- » Raw Water Temperature : 2 - 40
- » Power : AC100-240V / 50-60Hz
- » Inlet & Outlet : 3/4 inch
- » Pure Water Flow : 1.5 m /h
- » Net Weight (without salt) : ≤ 20kg
- » Machine Dimension : 347x347x625 mm



FCV-16-20

- » Raw Water : Municipal Tap water
- » Working Pressure : 0.15 - 0.5 Mpa
- » Raw Water Temperature : 2 - 40
- » Power : AC100-240V / 50-60Hz
- » Inlet & Outlet : 3/4 inch
- » Pure Water Flow : 1.5 m /h
- » Net Weight (without salt) : ≤ 20kg
- » Machine Dimension : 347x347x625 mm

iSOFT



FCV-12-05

Features :

- » Individual resin tank for Hot and Cold Water
- » Single control valve allows you to choose between Soft Water, Source Water, or Shut Off
- » High Quality and high efficiency resin
- » Quick and simply regeneration
- » No Separate brine tank required
- » Packing Dimension : 540 x 380 x 160 mm



Features :

- » LCD large screen with 7 languages available-English, Chinese, French, Russian, Spanish, Italian and German
- » Measurement units optional (L, gal, m3)
- » High quality resin tank with the characteristic of high temperature resistance
- » With food grade ion exchange resin, Good performance, long lifespan
- » Resin regeneration adjustable
- » Adjustable resin regeneration mode/ raw water only/ regeneration/ soft water only
- » Machine Dimension : 347x347x625 mm



Installation Diagram

Mini Sofi Smart Water Softener



Smart Water Softener



Cover is available



FCV-09-10(T)

Features & Benefits

- » Smart Regeneration for efficient operation
- » Digitally programmable
- » Very easy to use
- » Robust water Cabinet
- » Digital Control Valve
- » Compact Size

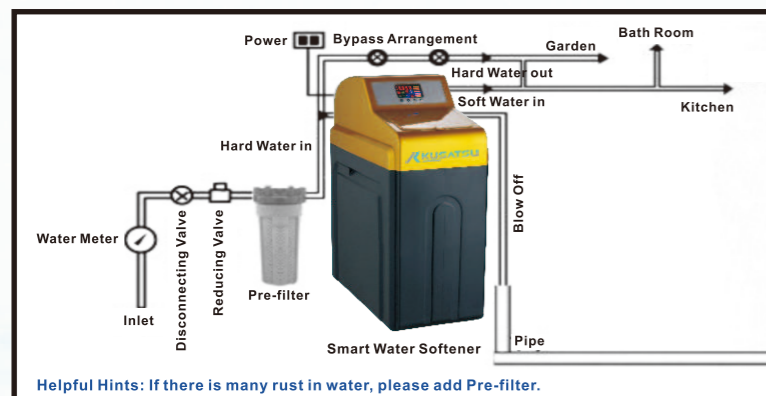

Installation Diagram

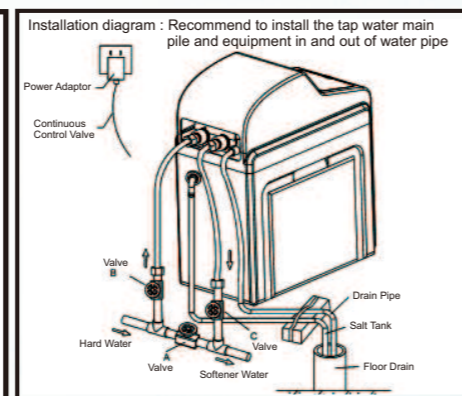

Installation Construction

Item No.	FCV-09-10	FCV-09-15	FCV-09-25
Regeneration Cycle	3 Days (Programmable)	3 Days (Programmable)	3 Days (Programmable)
Default regeneration start time	2:00 (Programmable)	2:00 (Programmable)	2:00 (Programmable)
Regeneration time	Approx 60 Minutes	Approx 60 minutes	Approx 60 minutes
Inlet Water quality	Standard Municipal Water	Standard Municipal Water	Standard Municipal Water
Rating Flow	≤ 0.5 ton /Hour	≤ 1.5 ton /hour	≤ 2.5 ton /hour
Optimal Working Pressure	0.15-0.30 MPa	0.15-0.30 Mpa	0.15-0.30 Mpa
Inlet Water Temperature	1-45 °C	1-45 °C	1-45 °C
Power Supply	100~220V/ 50~60Hz	110~220V/ 50~60Hz	110~220V/ 50~60Hz
Resin Volume	4 L	6.5 L	13 L
Machine Dimension (L*W*H mm)	400x220x480	400x220x590	400x200x1045
Packing Dimension (L*W*H mm)	460x265x535	460x265x670	460x265x1180
Unit Weight	≤ 15 Kgs (Net Weight, not including Salt)	≤ 20 Kgs (Net Weight, not including Salt)	≤ 25 Kgs (Net Weight, not including Salt)

Smart Water Softener

Three sizes available with Digital Control Auto-Soften Valve



FCV-11-10



FCV-11-15



FCV-11-25

Three sizes available with FLECK VALVE

FLECK



FCV-11A-10



FCV-11A-15



FCV-11-25

Item No.	FCV-11-10 FCV-11A-10	FCV-11-15 FCV-11A-15	FCV-11-25 FCV-11A-25
Regeneration Cycle	3 Days (Programmable)	3 Days (Programmable)	3 Days (Programmable)
Default Regeneration Start Time	2:00 (Programmable)	2:00 (Programmable)	2:00 (Programmable)
Regeneration Time	Approx 60 minutes	Approx 60 minutes	Approx 60 minutes
Inlet Water Quality	Standard Municipal Water	Standard Municipal Water	Standard Municipal Water
Rating Flow	≤ 0.5 Ton / Hour	≤ 1.5 Ton / Hour	≤ 2.5 Ton / Hour
Optimal Working Pressure	0.15-0.30 MPa	0.15-0.30 MPa	0.15-0.30 MPa
Inlet Water Temperature	1-45°C	1-45°C	1-45°C
Power Supply	110~220V/50~60Hz	110~220V/50~60Hz	110~220V/50~60Hz
Resin Volume	4 L	6.5 L	13 L
Machine Dimension (L*W*H mm)	400x220x480	400x220x590	400x220x1045
Packing Dimension (L*W*H mm)	460x265x535	460x265x670	460x265x1180
Unit Weight	≤ 15 Kgs (Net Weight, not including Salt)	≤ 20 Kgs (Net Weight, not including Salt)	≤ 25 Kgs (Net Weight, not including Salt)

Central Water Purifier



ZYF-01A



ZYF-01B



ZYF-02A



ZYF-02B

Item No.	ZYF-01A / ZYF-01B
Housing Material	SS304
Source Water	City Tap Water
Water Flow	1000L/H (2000~6000L/H for option)
Inlet Water Pressure	0.15~0.3 Bar
Suitable temp.	5~45°C
Filter Media	KDF+Coconut Carbon+Quartz Sand
Control Valve	Digital or Manual
Product Size	Ø 264x1550mm

Features :

- » Imported Qualified KDF Filter Material Can Effectively Eliminate the deleterious heavy metal ion in water
- » Qualified coal activated carbon filter material can Eliminate heterochromia and peculiar smell
- » Quartz sand can remove particle substance
- » To process water safe for drinking
- » Great performance and long service life
- » Convenient to be replaced with filters

Item No.	ZYF-02A / ZYF-02B
Housing Material	SS304
Source Water	City Tap Water
Water Flow	1000L/H (2000~6000L/H for option)
Inlet Water Pressure	0.15~0.3 Bar
Suitable temp.	5~45°C
Filter Media	KDF+Coconut Carbon+Quartz Sand
Control Valve	Digital or Manual
Product Size	Ø 264x1500mm

Features :

- » Imported Qualified KDF Filter Material Can Effectively Eliminate the deleterious heavy metal ion in water
- » Qualified coal activated carbon filter material can Eliminate heterochromia and peculiar smell
- » Quartz sand can remove particle substance
- » To process water safe for drinking
- » Great performance and long service life
- » Convenient to be replaced with filters

Ultraviolet Water Sterilizer

OSRAM OSRAM UV Lamps

OSRAM PURITEC® HNS®.
A Clean bill of health - ultraviolet light for disinfection.

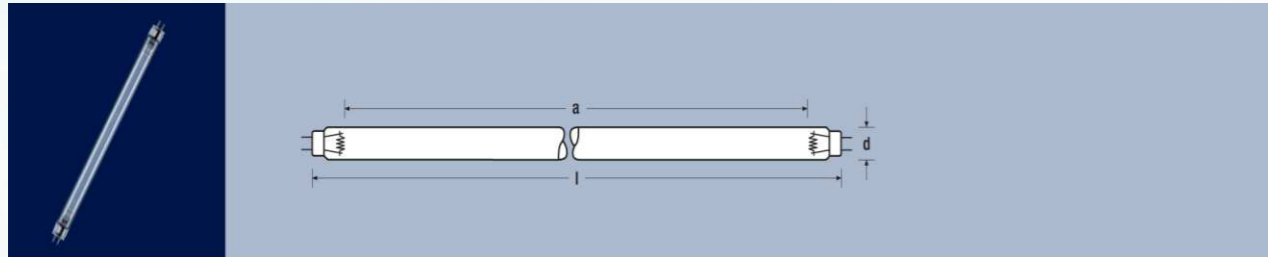

Product-reference	Product-number	W	V	A	UVC/W	l [mm]	a [mm]	b [mm]	Start	t [h]	Icon		
OSRAM PURITEC® HNS® low-pressure lamps					254 nm								
HNS 4W G5	4008321378323	4	29	0,17	0,9	134	79	15,5	s180	G5	ST111	6.000	25
HNS 6W G5	4008321378347	6	42	0,16	1,7	210	154	15,5	s180	G5	ST111	8.000	25
HNS 8W G5	4008321378392	8	56	0,15	2,5	287	230	15,5	s180	G5	ST111	8.000	25
HNS 11W G5	4008321927811	11	33	0,41	2,5	212	154	15,75	s180	G5	ST111	8.000	25
HNS 15W G13	4008321054227	15	55	0,3	4,9	436	354	25,5	s180	G13	ST111	8.000	20
HNS 25W G13	4008321054258	25	46	0,6	6,9	436	351	25,5	s180	G13	ST111	8.000	20
HNS 30W G13	4008321398895	30	96	0,36	13,4	893	808	25,5	s180	G13	ST111	8.000	10
HNS 55W G13	4008321054319	55	83	0,77	18	893	808	25,5	s180	G13	ST111	8.000	10

Operated with suitable control gear for fluorescent lamps, except for 1 with 13 W output. Other types are available on request. *economical lifetime

PHILIPS UV Lamps

GPM	Spec.	Dimension (mm)							Lamp Head Diameter	Quantity of UV Lamps
		A	B	C	G	Φ	Quartz Sleeve	UV Lamp		
0.25G	4W	236		164	1/4"	2"	230	150	16	1
0.5G	6W						226.3	1		
1G	11W			300			227	296		226.3
2G	16W	330	305	260	1/2"	2.5"	360	302.5	26	1
6G	25W	470	448	378			498	451.6		1
10G	30W	927	905	835			3/4"	5"		955
12G	55W				1"	1				
24G	110W				1.5"	2				
36G	165W									3

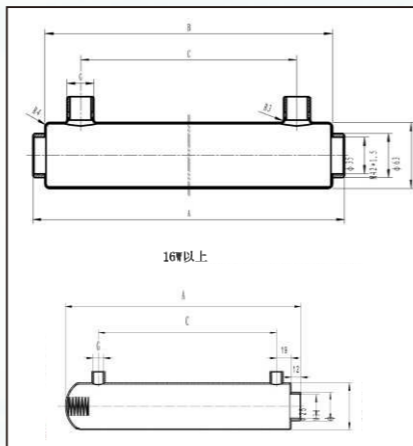

Ultraviolet Water Sterilizer

KUSATSU UV Lamps

GPM	Specification	Dimension(mm)						Quartz Sleeve	UV LAMP	Quantity of UV Lamp
		A	B	C	G	Φ				
0.25G	4W	236		164	1/4"	2"	230	215	1	
0.5G	6W								215	1
1G	12W			300				227	287	1
2G	16W	330	305	260	1/2"	2.5"	360	345	1	
6G	25W	550	525	481			580	565	1	
8G	30W	869	844	794			900	885	1	
10G	35W	910	885	835	3/4"	5"	940	925	1	
12G	55W				1"				1	
24G	110W				1.5"				2	
36G	165W				3"	8"			3	
48G	220W								4	
96G	440W								8	

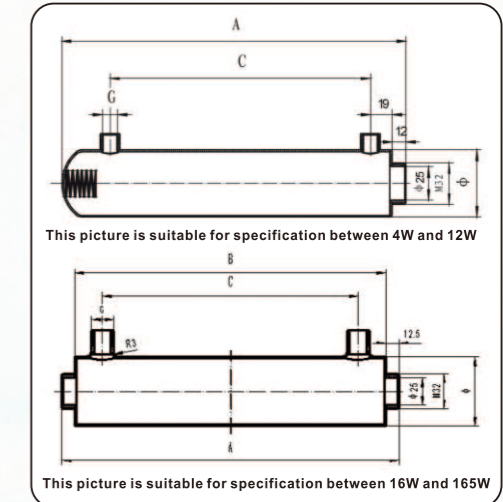

Double Filter

US-2U

10" Disposable Cartridge - PP 5u + CTO
(PP 1u and GAC Available) + UV
Packing Dimension : 580x300x370mm/4pcs



Triple Filter

US-3U

10" Disposable Cartridge - PP 5u + CTO
PP 5u + GAC + CTO (PP 1u Available) + UV
Packing Dimension : 580x420x370mm/4pcs



UV-Plus Water Purifier

US-3U

» 1st Stage : PP-10 PP Spun Fiber Filter
» 2nd Stage : GAC-10 Granular Carbon Filter
» 3rd Stage : CTO-10 Block Carbon Filter
» 4th Stage : UV-6 Ultraviolet Water Sterilizer
» 5th Stage : T-33T2 Ineral Ball
» Packing Dimension : 820x410x480mm/4pcs

Ultraviolet Water Sterilizer



UV-4/6W

» Packing Dimension : 50x38x74cm/18pcs



UV-12W

» Packing Dimension : 50x38x74cm/18pcs



UV-16W

» Packing Dimension : 46x36x37/6pcs
(Normal UV Lamp or Philips UV Lamp)



UV-6P

» With High Quality Plastic Shell
» Packing Dimension : 73.5x48.5x35.5cm/18pcs



UV-25/30W With Shelf

» Packing Dimension - 25W : 65x38x43cm/6pcs
» Packing Dimension - 30W : 96.5x38x43cm/6pcs



UV-35/55W

» Packing Dimension : 100x56.5x10cm/5pcs



UV-35/55W With Shelf

» Packing Dimension : 99.5x36x43cm/6pcs



UV-110W With Electric Controller

» Packing Dimension : 100x18x37cm/pcs



UV-110W With Shelf

» Packing Dimension : 100x18x32.5cm/pcs



UV-165W With Electric Controller

» Packing Dimension : 100x18x37cm/pcs



UV-165W With Shelf

» Packing Dimension : 100x18x32.5cm/pcs

NanoFiltration Membrane

Membrane Sheet **dry type**

Technology **USA**

New



NanoFiltration Membrane Date Sheet

Model		NF-1812-150	NF-2012-250	NF-2812-500	NF-3012-600
Performance	Average Rejection (%)	80	80	80	80
	Permeate Flux GPD	150(0.56)	250(0.95)	500(1.9)	600(2.27)
	Active Area ft ² (m ²)	3.5(0.32)	5.0(0.46)	12(1.13)	14(1.3)
	Membrane Bag Number	2	3	7	8
Tset Condition	Test Pressure	90psi(0.6Mpa)			
	Test Temp	25°C			
	NaCl Concentration (ppm)	250ppm			
	PH	7.5			
Operating Limit	Recovery (%)	60%			
	Max Pressure	300psi(21bar)			
	Max Feed Flow Rate	2gpm			
	Max Operating Temp.	45°C			
	Max SDI (Inlet)	5			
	Free Chlorine Tolerance	<0.1ppm			
	PH Range (Continuous Operation)	3~10			
	PH Range (Chemical Cleaning)	2~11			
Single Membrane element maximum pressure drop	10psi(0.07Mpa)				
Single Membrane element water output may change within +/- 20%					
Dry Membrane element storage temperature not higher than 45°C					

UltraFiltration Membrane



UF-10Q

Quick Fitting Build-in
UF Membrane
UF Membrane Inside

Water Flow	2.0 L/M
Test Temp.	25°C
Test Pressure	0.1Mpa
Packing Dimension : 340x340x360mm/25pcs	



UF-10F

Bayonet Cartridge
UF Membrane Inside

Water Flow	2.0 L/M
Test Temp.	25°C
Test Pressure	0.1Mpa
Packing Dimension : 370x370x295mm/25pcs	



UF-10C

UF Membrane

Water Flow	2.5 L/M
Test Temp.	25°C
Test Pressure	0.1Mpa
Packing Dimension : 690x620x410mm/200pcs	



UF-10S

UF Membrane

Water Flow	2.5 L/M
Test Temp.	25°C
Test Pressure	0.1Mpa
Packing Dimension : 690x260x350mm/50pcs	

Filmtec RO Membrane



FILMTEC 50GPD

Packing Dimension : 340x340x360mm/25pcs



FILMTEC 75GPD

Packing Dimension : 340x340x360mm/25pcs



FILMTEC 100GPD

Packing Dimension : 340x340x360mm/25pcs

Product Name	Permeate Flow Rate gpd (m ³ /d)	Stabilized Salt Rejection (%)	Minimum Salt Rejection (%)
FILMTEC TW30-1812-50	50 (0.19)	98.0	98.0
FILMTEC TW30-1812-75	75 (0.28)	98.0	98.0
FILMTEC TW30-1812-100	100 (0.38)	98.0	98.0

» Permeate flow and salt rejection based on the following test conditions :
250 ppm softened tapwater, 77°F (25°C), 50 psig (3.4 Bar), & 15% Recovery
» Permeate flow rates for individual elements may vary +/-20%

Kusatsu 'TORAY' RO Membrane



Technology USA

Membrane Sheet Dry Type

Wet Membrane for Option

KUSATSU 'TORAY' RO Membrane Model Data Sheet

Model	TW1812-50	TW1812-75	TW1812-80	TW1812-90	TW1812-100	TW2012-125	TW2012-150	TW2812-200	TW3012-300	TW3012-400	
Performance	Average Rejection(%)	97	97	97	97	97	97	97	97	97	
	Permeate Flux GPD	50	75	80	90	100	125	150	200	300	
	Active Area(ft ² m ²)	0.36	0.36	0.38	0.45	0.54	0.54	0.54	1.26	1.26	
Tset Condition	Test Pressure	70psi(0.4Mpa)									
	Test Temp.	25 °C									
	NaCl Concentration(ppm)										
	PH	7.5									
Operating Limit	Recovery(%)										
	Max Pressure	300psi(21bar)									
	Max feed flow rate										
	Max operating temp	45 °C									
	Max SDI (inlet)										
Free chlorine tolerance	Free chlorine tolerance	<0.1ppm									
	PH range(continuous operation)										
	PH rang(chemical cleaning)	2~11									



ROH-10B
» Double O-Ring
» RO Membrane Housing
For 50, 75, 80, 100, 125GPD

ROH-10BB
» Single O-Ring
» RO Membrane Housing
For 200, 300GPD

Quick Fitting RO Membrane Cartridge
» KUSATSU-50G-Q
» KUSATSU-75G-Q
» KUSATSU-100G-Q
» KUSATSU-150G-Q
» Packing Dimension : 340x340x345mm/25pcs

Quick Fitting RO Membrane
» KUSATSU-50G-Q2
» KUSATSU-75G-Q2
» KUSATSU-100G-Q2
» Packing Dimension : 34x34x36cm/25pcs

Kusatsu 'TORAY' RO Membrane



Packing Dimension:

Item No.	50G/75G/80G/90G/100G/125G/150G	200G/300G/400G
Dimension	31x31x32cm/25pcs	34x34x36cm/16pcs

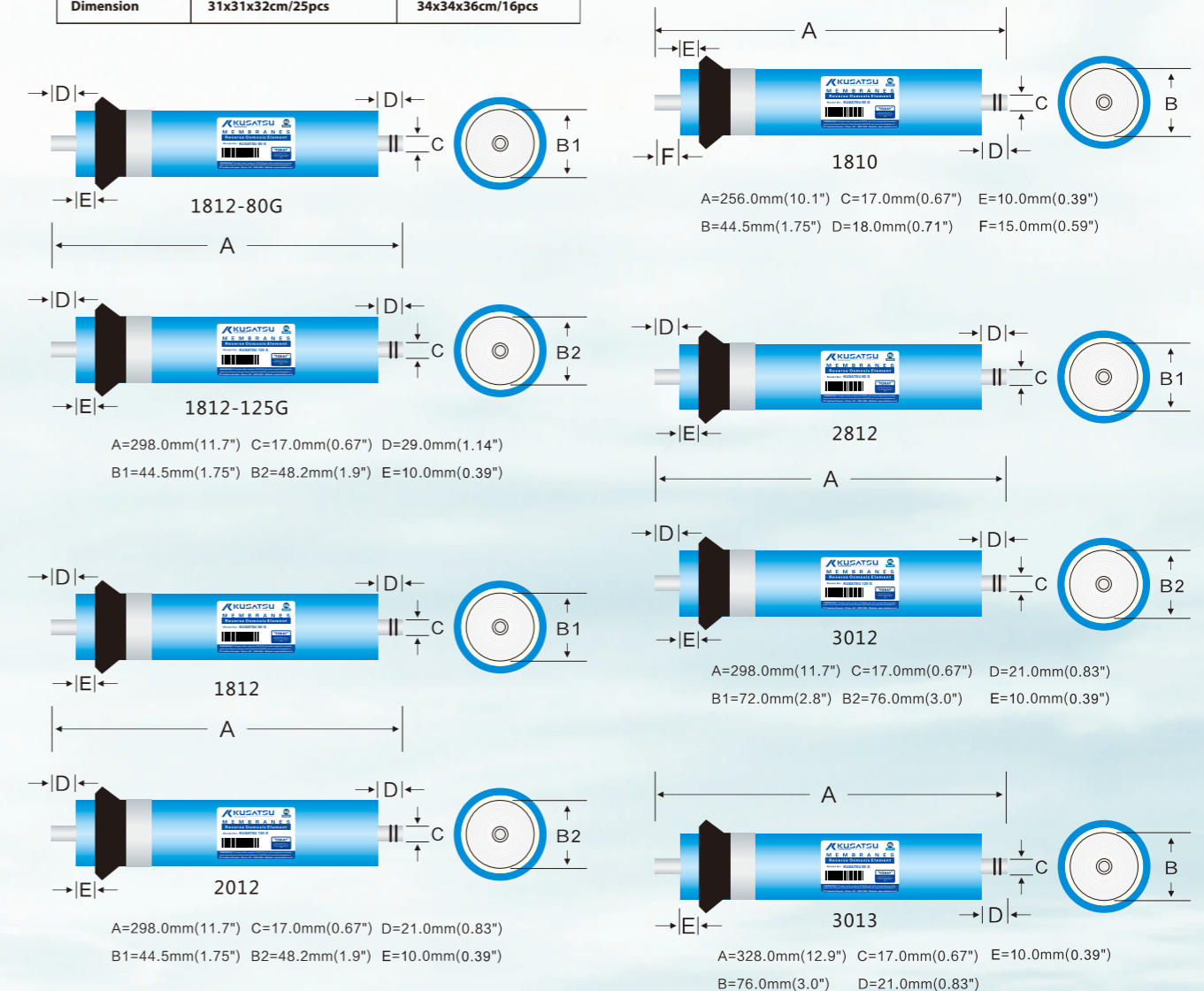

Filter Cartridges



BAYONET FILTER CARTRIDGES

Ratio of desalinization : greater than 96%

Change filters in seconds without shutting off water! No tools required!

Bayonet Cartridges

Filter Cartridges

BAYONET FILTER CARTRIDGES

Change filters in seconds without shutting off water! No tools required!

Bayonet Cartridges



PP-10CF

- » Temperature : 5~45°C
- » Service Life : 5000L
- » Flow : 3L/Min
- » Pressure : 0.1~1.5Mpa



GAC-10CF

- » Temperature : 5~45°C
- » Service Life : 5000L
- » Flow : 3L/Min
- » Pressure : 0.1~1.5Mpa



CTO-10CF

- » Temperature : 5~45°C
- » Service Life : 5000L
- » Flow : 3L/Min
- » Pressure : 0.1~1.5Mpa



T33-10CF

- » Temperature : 5~45°C
- » Service Life : 5000L
- » Flow : 3L/Min
- » Pressure : 0.1~1.5Mpa



RO-10CF

- » Temperature : 5~45°C
- » Service Life : 4000L
- » Flow : 0.38L/Min
- » Pressure : 0.1~1.5Mpa



UF-10CF

- » Temperature : 5~45°C
- » Service Life : 5000L
- » Flow : 3L/Min
- » Pressure : 0.1~1.5Mpa



MTP-10CF

- » Temperature : 5~45°C
- » Service Life : 5000L
- » Flow : 2L/Min
- » Pressure : 0.1~1.5Mpa



PP-10F

- » PP Sediment
- » Packing Dimension : 38x38x31cm/25pcs
- » 2" or 3" Connection for Option



UF-10F

- » UF Cartridge
- » Packing Dimension : 38x38x31cm/25pcs
- » 2" or 3" Connection for Option



GAC-10F

- » Granular Carbon
- » Packing Dimension : 38x38x31cm/25pcs
- » 2" or 3" Connection for Option



CTO-10F

- » Block Carbon
- » Packing Dimension : 38x38x31cm/25pcs
- » 2" or 3" Connection for Option



RO-10F

- » RO Cartridge
- » Packing Dimension : 38x38x31cm/25pcs
- » 2" or 3" Connection for Option



GAC-10F (C)

- » Packing Dimension : 38x38x31cm/25pcs
- » 2" or 3" Connection for Option

Filter Cartridges



QUICK FITTING FILTER CARTRIDGES



PP-28
 » Quick Fitting
 » PP Sediment
 » Packing Dimension
 34x34x36cm/25pcs



GAC-28
 » Quick Fitting
 » Garnular Carbon
 » Packing Dimension
 34x34x36cm/25pcs



CTO-28
 » Quick Fitting
 » Block Carbon
 » Packing Dimension
 34x34x36cm/25pcs



T33-28
 » Quick Fitting
 » Activated Carbon
 » Packing Dimension
 34x34x36cm/25pcs



T28T1
 » Quick Fitting
 » Medical Stone
 » Packing Dimension
 34x34x36cm/25pcs



T28T2
 » Quick Fitting
 » Mineralized Balls
 » Packing Dimension
 34x34x36cm/25pcs



UF-10Q2
 » Quick Fitting
 » UF Membrane
 » Packing Dimension
 34x34x36cm/25pcs



**KUSATSU-50G-Q2
 KUSATSU-75G-Q2
 KUSATSU-100G-Q2**
 » Quick Fitting
 » RO Membrane
 » Packing Dimension
 34x34x36cm/25pcs

Filter Cartridges



PP-33
 » Quick Fitting
 » PP Sediment
 » Packing Dimension
 340x340x360mm/25pcs



GAC-33
 » Quick Fitting
 » Garnular Carbon
 » Packing Dimension
 340x340x360mm/25pcs



CTO-33
 » Quick Fitting
 » Block Carbon
 » Packing Dimension
 340x340x345mm/25pcs



T33-33
 » Quick Fitting
 » Activated Carbon
 » Packing Dimension
 368x368x302mm/25pcs



T-33B1
 » Activated Carbon
 » Packing Dimension
 340x340x305mm/25pcs



T-33B3
 » PP Sediment
 » Packing Dimension
 340x340x305mm/25pcs



T-33B5
 » Resin
 » Packing Dimension
 368x368x302mm/25pcs



T-33B6
 » Coconut Carbon
 » Packing Dimension
 368x368x302mm/25pcs

Bio-Safe IODIZED RESIN CARTRIDGE

No UV needed anymore!



IODIZED RESIN
 Kills Viruses and bacteria with a 99.99% sterilization rate preventing secondary pollution of purified water

COCONUT CARBON
 Absorb residual chlorine and adjusts taste and odor

T-33I
 » Iodized Resin
 » Packing Dimension
 368x368x302mm/25pcs

Specification
 SPECIFICATION
 » Flow : 0.75gpm (2.8Lpm)
 » Pressure : 30-125psi
 » Service Life : 2500L
 » Temperature : 4.5-37.8° C
 » Sterilization Rate : 99.99%

Filter Cartridges

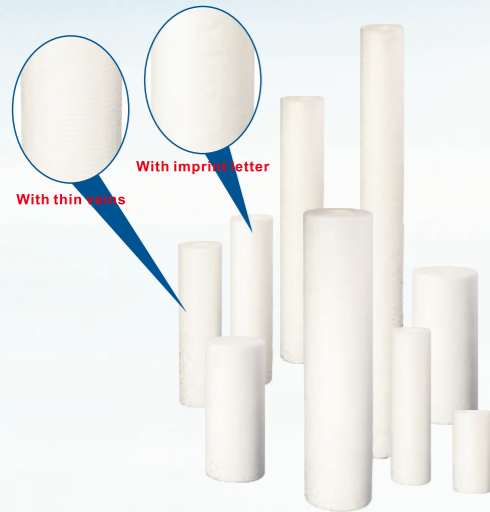

PP Spun Fiber

PP-10-X	PP-10-T	PP-10B
» 10" PP Spun Fiber Cartridge » Packing Dimension 33x33x53cm/50pcs	» 10" PP Spun Fiber Cartridge » Packing Dimension 33x33x53cm/50pcs	» 10" PP Spun Fiber Cartridge » For Big Blue Housing » Packing Dimension 59x24x53cm/20pcs
PP-5	PP-10	PP-20
» 5" PP Spun Fiber Cartridge » Packing Dimension 34x34x54cm/100pcs	» 10" PP Spun Fiber Cartridge » Packing Dimension 33.5x33.5x53cm/50pcs	» 20" PP Spun Fiber Cartridge » Packing Dimension 59x24x53cm/25pcs
PP-20B	PP-30	PP-40
» 20" PP Spun Fiber Cartridge » For Big Blue Housing » Packing Dimension 59x24x53cm/10pcs	» 30" PP Spun Fiber Cartridge » Packing Dimension 33x33x77cm/25pcs	» 40" PP Spun Fiber Cartridge » Packing Dimension 33x33x102cm/25pcs

Granular Carbon Cartridge



GAC-10	GAC-10S	GAC-103
» 10" Granular Carbon Cartridge » Packing Dimension 38x38x28cm/25pcs ①	» 10" Granular Carbon Cartridge » Packing Dimension 33x28x53/40pcs ②	» 10" Granular Carbon Cartridge » Packing Dimension 39x39x28cm/25pcs ③
GAC-104	GAC-10B	GAC-10E
» 10" Granular Carbon Cartridge » Packing Dimension 39x39x28cm/25pcs ④	» 10" Granular Carbon Cartridge » For Big Blue Housing » Packing Dimension 36x25x53cm/12pcs ⑤	» 10" Granular Carbon Cartridge » Packing Dimension 39x39x28cm/25pcs ⑥
GAC-102	GAC-20B	GAC-20
» 10" Granular Carbon Cartridge » Packing Dimension 40x30x26cm/20pcs ⑦	» 20" Granular Carbon Cartridge » For Big Blue Housing » Packing Dimension 36x25x53cm/6pcs ⑧	» 20" Granular Carbon Cartridge » Packing Dimension 53x39x31cm/20pcs ⑨
GAC-20S	GAC-202	GAC-5
» 20" Granular Carbon Cartridge » Packing Dimension 39x33x55cm/20pcs ⑩	» 20" Granular Carbon Cartridge » Packing Dimension 53x39x31cm/20pcs ⑪	» 5" Granular Carbon Cartridge » Packing Dimension 39x39x28cm/50pcs

Block Carbon



CTO-10	CTO-04	CTO-20B
» 10" Block Carbon Cartridge » Packing Dimension 38x38x28cm/25pcs	» 4" Block Carbon Cartridge » Packing Dimension 38x38x20cm/25pcs	» 20" Block Carbon Cartridge » For Big Blue Housing » Packing Dimension 36x25x53cm/6pcs
CTO-10B	CTO-5	
» 10" Block Carbon Cartridge » For Big Blue Housing » Packing Dimension 36x25x53cm/12pcs	» 5" Block Carbon Cartridge » Packing Dimension 38x38x28cm/25pcs	
CTO-20	CTO-7	
» 20" Block Carbon Cartridge » Packing Dimension 53x39x31cm/20pcs	» 7" Block Carbon Cartridge » Packing Dimension 38x38x30cm/25pcs	

Filter Cartridges

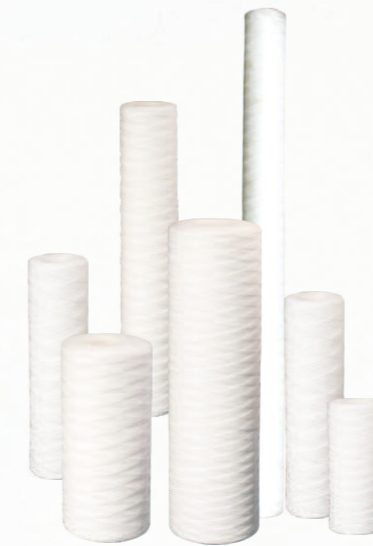

PP Yarn Cartridge

PS-5	PS-10	PS-10B
» 5" PP Yarn Cartridge » Packing Dimension 33x33x53cm/100pcs	» 10" PP Yarn Cartridge » Packing Dimension 33x33x53cm/50pcs	» 10" PP Yarn Cartridge » For Big Blue Housing » Packing Dimension 59x24x53cm/20pcs
PS-20B	PS-30	PP-40
» 20" PP Yarn Cartridge » For Big Blue Housing » Packing Dimension 59x25x53cm/10pcs	» 30" PP Yarn Cartridge » Packing Dimension 33x33x77cm/25pcs	» 40" PP Yarn Cartridge » Packing Dimension 33x33x102cm/25pcs
PS-20		
» 20" PP Yarn Cartridge » Packing Dimension 33x32x53cm/25pcs		



Pleated Cartridge

PL-10	PL-10B01	PL-101
» 10" Pleated Cartridge » Packing Dimension 33x33x53cm/50pcs ①	» 10" Pleated Cartridge » For Big Blue Housing » Packing Dimension 39x39x53cm/18pcs ②	» 10" Pleated Cartridge » Packing Dimension 39x39x53cm/50pcs ③
PL-10B	PL-20	PL-20B
» 10" Pleated Cartridge » For Big Blue Housing » Packing Dimension 39x39x53cm/18pcs ④	» 20" Pleated Cartridge » Packing Dimension 33x33x53cm/25pcs ⑤	» 20" Pleated Cartridge » For Big Blue Housing » Packing Dimension 39x39x53cm/9pcs ⑥



MIC Pleated Cartridge

MIC-10S	MIC-101	MIC-102
» 10" MIC Pleated Cartridge » Packing Dimension 39x39x28cm/25pcs ①	» 10" MIC Pleated Cartridge » Packing Dimension 39x39x28cm/25pcs ②	» 10" MIC Pleated Cartridge » Packing Dimension 39x39x28cm/20pcs ③
MIC-10R	MIC-10	MIC-20R
» 10" MIC Pleated Cartridge » Packing Dimension 39x39x28cm/25pcs ④	» 10" MIC Pleated Cartridge » Packing Dimension 39x39x28cm/25pcs ⑤	» 20" MIC Pleated Cartridge » Packing Dimension 38x38x53cm/25pcs ⑥
MIC-20		
» 20" MIC Pleated Cartridge » Packing Dimension 38x38x53cm/25pcs ⑦		

Filter Cartridges



CPP-10 » 10" Grooved Cartridge Grooved By Cutter » Packing Dimension 33x33x53cm/50pcs	PUDF-101 » 10" PP Spun Fiber and Granular Carbon Cartridge » Packing Dimension 38x38x28cm/25pcs	PUDF-102 » 10" PP Spun Fiber and Granular Carbon Cartridge » Packing Dimension 38x38x28cm/25pcs	ION-101 » 10" Resin Filter Cartridge » Packing Dimension 39x39x38cm/25pcs	ION-102 » 20" Resin Filter Cartridge » Packing Dimension 53.5x39x32cm/20pcs	ION-102 » 10" Resin Filter Cartridge » Packing Dimension 38x38x28cm/25pcs	ION-102(C) » 10" Activated Carbon Filter Cartridge » Packing Dimension 38x38x28cm/25pcs	FR-10 » 10" Carbon Fiber Cartridge » Packing Dimension 33x28x53cm/20pcs
--	--	--	--	--	--	--	--



CE-101 » 10" Ceramic Filter » Packing Dimension 33x33x53cm/50pcs	CE-102S » 10" Ceramic Filter	CE-103 » 10" Ceramic Filter » Packing Dimension 33x28x53cm/20pcs	CE-104 » 10" Ceramic Filter » Packing Dimension 49x31x32cm/40pcs	SP-10 » 10" Siliphos Cartridge » Packing Dimension 38x38x28cm/25pcs	SFC-10 » 10" Net Filter Cartridge » Packing Dimension 33x33x53cm/50pcs	SFC-5 » 5" Net Filter Cartridge » Packing Dimension 33x33x53cm/100pcs	PH-10 » PH Filter Cartridge » Packing Dimension 50x34x25cm/40pcs » PH-10 : Empty » PH-10A : Alum Inside » PH-10B : Siliphos Inside
---	--	---	---	--	---	--	--



T-33P » PP Sediment » Packing Dimension 27x27x27cm/25pcs	T-33C » Activated Carbon » Packing Dimension 27x27x27cm/25pcs	T-33T2 » Mineral Ball » Packing Dimension 27x27x27cm/25pcs	T-33Q » Quick Fitting Activated Carbon » Packing Dimension 27x27x27cm/25pcs	T-33Q(A) » Quick Fitting Alkaline Mineralized Balls » Packing Dimension 27x27x27cm/25pcs	T-33 » Activated Carbon » Packing Dimension 27x27x27cm/25pcs	T-33M » Magnet Inside
---	--	---	--	---	---	---------------------------------



T-33S » Acid-Washed Block Carbon » Packing Dimension 29x29x29cm/25pcs	T-33T3 » Activated Carbon » Packing Dimension 27x27x27cm/25pcs	T-33T1 » Mineral Stone » Packing Dimension 27x27x27cm/25pcs	T-33E » Far Infrared Cartridge » Packing Dimension 27x27x27cm/25pcs	T-33F1 » Far Infrared Cartridge » Packing Dimension 39.5x39.5x33.5cm/25pcs	T-22B » Activated Ceramic Ball
--	---	--	--	---	--

Filter Cartridges

Features

- » Material Nano Antiscale Carbon CTO-10
- » Function : Remove the Odorous odor, Residual Chlorine, Colloids and suspended solids in the Water and remove the scale
- » Technical Parameters :
Water hardness ≤ 600mg/L
Inlet Water Temperature : 5-45°C
- » Pure Water Flow : 2L/min
- » Rated Water Flow : 2500L
- » Suggested Replacement Time : 6 Months

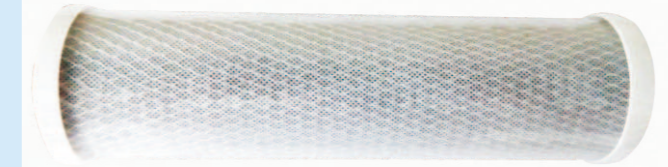

Comparison of Boiling Water Before and After Using Nano Antiscl Carbon :

1. Testing Water Hardness : 240mg/L
(Water Hardness is 240mg/L, Alkalinity : 4.46mmol/L)

Alkalinity	3.87mmol/L	5.28mmol/L	6.45mmol/L
Antiscale Ratio	92%	83.3%	77.9%

2. Testing Water Hardness : 300mg/L

Alkalinity	3.87mmol/L	5.28mmol/L	6.45mmol/L
Antiscale Ratio	87%	77.7%	71.3%

3. Testing Water Hardness : 600mg/L

Alkalinity	3.87mmol/L	5.28mmol/L	6.45mmol/L
Antiscale Ratio	95.3%	90.3%	70%

Comparison of Water Before and After Using Nano Antiscl Carbon :

1. Testing Water Hardness : 300mg/L, Testing Water Phenolphthalein Alkalinity : 2.0 mmol/L
Comparison of Water Before and After Using Nano Antiscale Carbon



(The Left one is Tap Water, the Right One is Water Filtered by Nano Antiscale Carbon)

2. Testing Water Hardness : 450mg/L, Testing Water Phenolphthalein Alkalinity : 2.0 mmol/L

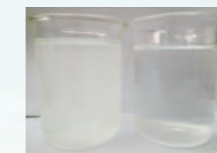

(The Left one is Tap Water, the Right One is Water Filtered by Nano Antiscale Carbon)

Total Hardness of Raw Water	300mg/L	450mg/L
Antiscale Ratio	95.3%	90.7%

Filter Housings



Model No. 122-10Y-W
10" Single O-Ring
White Housing
1/4" Plastic Port
White Cap
Packing Dimension 47x36x33cm/12pcs

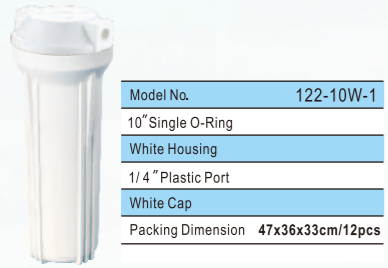

Model No. 122-10W-1
10" Single O-Ring
White Housing
1/4" Plastic Port
White Cap
Packing Dimension 47x36x33cm/12pcs

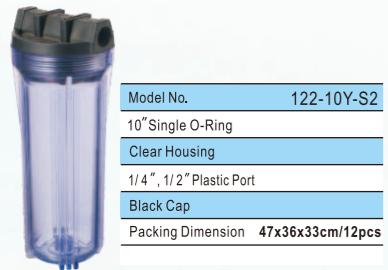

Model No. 122-10Y-S2
10" Single O-Ring
Clear Housing
1/4", 1/2" Plastic Port
Black Cap
Packing Dimension 47x36x33cm/12pcs



Model No. 122-10N-L01
10" Single O-Ring
Blue Housing
1/2", 3/4" Plastic or Brass Port
Black Cap
Packing Dimension 47x36x33cm/12pcs



Model No. 121B-10
10" Single O-Ring
Blue Housing
1/2", 3/4", 1" Plastic or Brass Port
Black Cap with Pressure Relief
Packing Dimension 53.5x40x33cm/12pcs



Model No. 121-10B
10" Single O-Ring
Blue Housing
3/4", 1/2", 1" Plastic Port or 3/4", 1" Brass Port
Black Cap with Pressure Relief
Packing Dimension 47x36x33cm/12pcs



Model No. 128-10S
10" Double O-Ring
Clear Housing
1/4" Plastic Port
White Cap
Packing Dimension 47x36x33cm/12pcs



Model No. 122-10Y-S1
10" Single O-Ring
Clear Housing
1/4" Plastic Port
White Cap
Packing Dimension 47x36x33cm/12pcs



Model No. 122-10N-L
10" Single O-Ring
Blue Housing
1/2", 3/4" Plastic or Brass Port
Black Cap with Pressure Relief
Packing Dimension 47x36x33cm/12pcs



Model No. 122-10N-S01
10" Single O-Ring
Clean Housing
1/2", 3/4" Plastic or Brass Port
Black Cap
Packing Dimension 47x36x33cm/12pcs

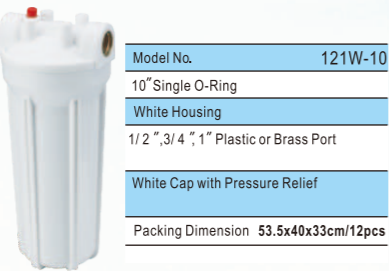

Model No. 121W-10
10" Single O-Ring
White Housing
1/2", 3/4", 1" Plastic or Brass Port
White Cap with Pressure Relief
Packing Dimension 53.5x40x33cm/12pcs



Model No. 121-10A
10" Single O-Ring
Clean Housing
3/4", 1/2", 1" Plastic Port or 3/4", 1" Brass Port
Blue Cap with Pressure Relief
Packing Dimension 58x44x35cm/12pcs

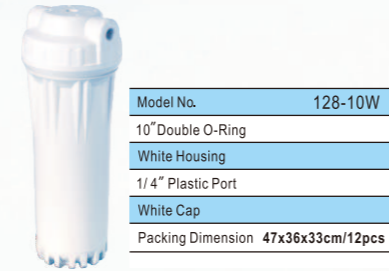

Model No. 128-10W
10" Double O-Ring
White Housing
1/4" Plastic Port
White Cap
Packing Dimension 47x36x33cm/12pcs



Model No. 122-10S-1
10" Single O-Ring
Clear Housing
1/4" Plastic Port
White Cap
Packing Dimension 47x36x33cm/12pcs



Model No. 122-10N-S
10" Single O-Ring
Clean Housing
1/2", 3/4" Plastic or Brass Port
Black Cap with Pressure Relief
Packing Dimension 47x36x33cm/12pcs



Model No. 123-10
10" Single O-Ring
Clean Housing
1/2", 3/4" Plastic or Brass Port
Black Cap with Pressure Relief
Packing Dimension 55x40x35cm/12pcs



Model No. 121T-10
10" Single O-Ring
Clean Housing
1/2", 3/4", 1" Plastic or Brass Port
White Cap with Pressure Relief
Packing Dimension 53.5x40x33cm/12pcs



Model No. 122-20S
20" Single O-Ring
Slim Clear Housing
3/8", 1/2", 3/4", 1" Plastic or Brass Port
Clean Cap with Pressure Relief
Packing Dimension 58x40x27cm/6pcs



Model No. 124-10
10" Single O-Ring
Big Blue Housing
3/4", 1", 1.25", 1.5" Plastic or Brass Port
Black Cap with Pressure Relief
Packing Dimension 43x43x39cm/4pcs



Model No. 125-10D
10" Single O-Ring
Double Clear Housing
1/2", 3/4", 1" Brass
Blue Cap
Packing Dimension 80x32x35cm/5pcs



Model No. 125-5
5.25" Single O-Ring
Clear Housing
1/2", 3/4", 1" Brass
Port Blue Cap
Packing Dimension 77x33x30cm/10pcs

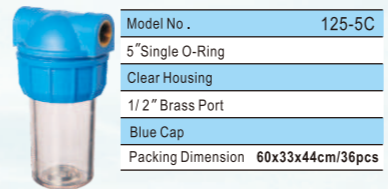

Model No. 125-5C
5" Single O-Ring
Clear Housing
1/2" Brass Port
Blue Cap
Packing Dimension 60x33x44cm/36pcs



Model No. 122-20
20" Single O-Ring
Slim Blue Housing
3/8", 1/2", 3/4", 1" Plastic or Brass Port
Black Cap with Pressure Relief
Packing Dimension 58x40x27cm/6pcs



Model No. 124-10S
10" Single O-Ring
Big Blue Housing
3/4", 1", 1.25", 1.5" Plastic or Brass Port
Black Cap with Pressure Relief
Packing Dimension 43x43x39cm/4pcs



Model No. 127-10
10" Single O-Ring
Clear Housing
1/2", 3/4" Brass Port
Blue Cap
Packing Dimension 71x37x27cm/12pcs



Model No. 125-7
7" Single O-Ring
Clear Housing
1/2", 3/4", 1" Brass
Port Blue Cap
Packing Dimension 77.5x32x36.5cm/10pcs



Model No. 125-5E
5" Single O-Ring
Clear Housing
1/2" Brass Port
Blue Cap
Packing Dimension 62x42.5x34cm/36pcs



Model No. 型号 124-20
20" Single O-Ring
Big Blue Housing
3/4", 1", 1.25", 1.5" Plastic or Brass Port
Black Cap with Pressure Relief
Packing Dimension 63x40x39cm/4pcs



Model No. 型号 124-20S
20" Single O-Ring
Big Blue Housing
3/4", 1", 1.25", 1.5" Plastic or Brass Port
Black Cap with Pressure Relief
Packing Dimension 63x40x39cm/4pcs



Model No. 126-10
10" Single O-Ring
Clear Housing
3/4", 1" Brass Port
Blue Cap with Pressure Relief
Packing Dimension 58x40x27cm/6pcs



Model No. 125-10
10" Single O-Ring
Clear Housing
1/2", 3/4", 1" Brass
Port Blue Cap
Packing Dimension 78x32x36cm/10pcs



Model No. 125-5F
5" Single O-Ring
Clear Housing
1/2" Brass Port
Blue Cap
Packing Dimension 62x42.5x34cm/36pcs

Filter Media



Mineral Stone Adjusted level of mineral to water that has had all its mineral substances removed through RO Filtration



Far Infrared Mineralized Balls Emit Small Amounts of Far Infrared to Improve Water Quality and Odor



Quartz is used as a stable, wear proof filter media



Siliphos is Used to Protect Water Pipeline Systems from Corrosion



Ion Exchange Resin Removes Calcium and Magnesium Ions to Generate Soft Water



KDF is Used to treat heavy metal impurity and Organic Pollution in water

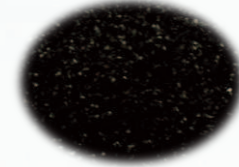

Coal Carbon is a Filter Media That Removes any Organics, Chlorine, Odor and Turbidity in Water



Coconut Carbon is a Filter Media That Removes any Organics, Chlorine, Odor and Turbidity in Water



Alkaline Mineral Balls, Adjust PH Valve to Alkaline, Which is Good for human body health

Faucet



GF-01
» Goose Faucet with Plastic Spout and Plastic Handle
» Packing Dimension 50x31x38mm/50pcs



GF-01C
» Goose Faucet with Chrome Spout and Plastic Handle
» Packing Dimension 50x31x38mm/50pcs



GF-01G
» Goose Faucet with Gold Spout and Plastic Handle
» Packing Dimension 50x31x38mm/50pcs



GF-02C
» Goose Faucet with Chrome Spout and Plastic Handle
» Packing Dimension 48x35x35mm/40pcs



GF-02S
» Goose Faucet with Chrome Spout and Chrome Handle
» Packing Dimension 47.5x34x39.5mm/40pcs



GF-02G
» Goose Faucet with Gold Spout and Gold Handle
» Packing Dimension 48x35x34mm/40pcs



GF-03C
» Goose Faucet with Chrome Spout and Chrome Handle
» Packing Dimension 59x37x44mm/50pcs



GF-04C
» Goose Faucet with Chrome Spout and Chrome Handle
» Packing Dimension 55x36x33mm/30pcs



GF-05
» Dual Function Faucet
» Packing Dimension 55x36x33mm/30pcs



GF-06
» Packing Dimension 55x36x33mm/30pcs



GF-06S
» Packing Dimension 48x37x71mm/50pcs



GF-07
» Dual Function Faucet
» Packing Dimension : 39x17.5x3.5cm/30pcs



GF-08
» Luxury Kitchen Faucet (For Tap Water & RO Water)
» Packing Dimension : 40x21x9cm/30pcs



GF-09
» Luxury Kitchen Faucet
» Packing Dimension : 39x18.5x6.5cm/30pcs

Pump

Booster Pump Technical Parameter

Environmental Temperature > 16°C Temperature : 25°C

Model	Voltage (V)	Current (A)	Inlet Water Pressure (PSI)	Outlet Water Pressure (PSI)	Flow Rate (ML/M)	Remark
BP-01 50G	24	≤ 0.75	28	80	≥ 500	Suitable adaptor: 24V 1.2A Restrictor: 370ml/min
BP-01 75G	24	≤ 0.9	28	80	≥ 650	Suitable adaptor: 24V 1.2A Restrictor: 450ml/min
BP-01 100G	24	≤ 1.2	28	80	≥ 950	Suitable adaptor: 24V 1.5A Restrictor: 680ml/min
BP-01 200G	24	≤ 1.5	28	80	≥ 1600	Suitable adaptor: 24V 2.0A Restrictor: 1080ml/min
BP-01 300G	24	≤ 1.7	28	80	≥ 2000	Suitable adaptor: 24V 3.0A
BP-01 400G	24	≤ 3.5	28	80	≥ 3000	Suitable adaptor: 24V 5.0A

BP-01

» Booster Pump
» Packing Dimension 40x33x12.5mm/6pcs

QAD-01

» Adaptor
» Input : 110V/220V
» Output : DC24V
» Frequency : 50/60Hz

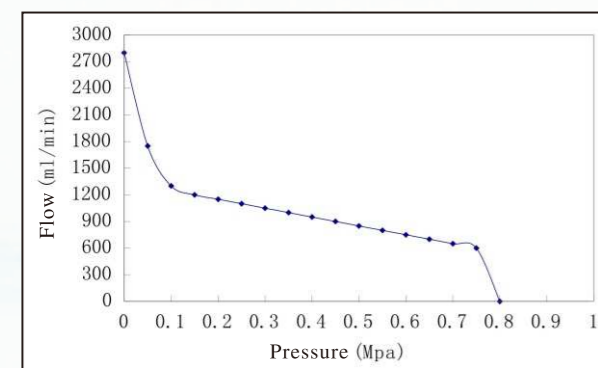

Pump Head Spare Parts and Fixing Sketch

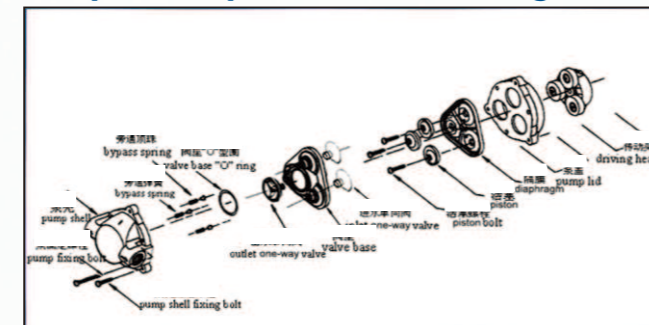

Tank



2.5G Smart Tank
» Packing Dimension : 20x20x35cm/1pc



3.0G Plastic Tank
» Packing Dimension : 28x28x42cm/1pc



4.0G Plastic Tank
» Packing Dimension : 28x28x42cm/1pc



2.0G Steel Tank
» Packing Dimension : 20x20x35cm/1pc



2.8G Steel Tank
» Packing Dimension : 24x24x36.5cm/1pc



3.0G Steel Tank
» Packing Dimension : 28x28x42cm/1pc



3.2G Steel Tank
» Packing Dimension : 28x28x38cm/1pc



6.0G Steel Tank
» Packing Dimension : 32x32x56cm/1pc



11G Steel Tank
» Packing Dimension : 42x42x60cm/1pc



20G Steel Tank
» Packing Dimension : 42x42x82cm/1pc



28G Steel Tank
» Packing Dimension : 42x42x103cm/1pc



28G Steel Tank
» Packing Dimension : 45x45x89cm/1pc



28G Steel Tank
» Packing Dimension : 49x49x104cm/1pc



28G Steel Tank
» Packing Dimension : 49x49x104cm/1pc

Wrench

WR-01 124 Series Housing Wrench This is suitable for 124-10	WR-02 RO Housing Wrench This is suitable for 122-10	WR-04 Table Water Filter Wrench This is suitable for FF-1	WR-05 Membrane Housing Wrench for 50G, 75G, 100G Membrane Housing	WR-06 Membrane Housing Wrench for 200G, 300G Membrane Housing	WR-07 Membrane Housing Wrench for N03, N03F Membrane Housing

Clamp

CL-03 Clamp 2.5" x 2.5"	CL-07 Clamp 2" x 2"	CL-04 Clamp 2" x 2.5"	CL-04B Clamp 2" x 3.5"	CL-05 Clamp 3.5"	CL-05B Clamp 3.5"	CL-06 Clamp 2"

Bracket

HG-0104 L: 8cm, W: 6cm, H: 10cm This is Suitable for NT-1 122-20	HG-0205 L: 19cm, W: 10cm, H: 4cm This is Suitable for NT-2	ROG-FFC L: 30cm, W: 11cm, H: 11.5cm H1: 8.5cm, H2: 3.5cm	ROG-FFB L: 36cm, W: 16cm, H1: 14cm, H2: 4cm	ROG-0201 L: 26cm, W: 15cm, H1: 14cm, H2: 3.5cm This is Suitable for RO-4	ROG-0304 L: 36cm, W: 15cm, H1: 14cm, H2: 3.5cm This is Suitable for WP-1 / WP-2 / RO-50G-E01	HGP-018 L: 11.8cm, W: 5.5cm, H: 44.5cm This is Suitable for Housing 121

HG-0201 L: 25cm, W: 10.8cm, H1: 4.6cm, H2: 3.5cm This is Suitable for US-2	HG-0305 L: 36cm, W: 15cm, H1: 4cm, H2: 1.5cm This is Suitable for NT-3	ROG-0301H (Black) L: 36cm, W: 17.5cm, H1: 14cm, H2: 3cm This is Suitable for RO-50G Series	ROG-0301Y (Silver) L: 36cm, W: 17.5cm, H1: 14cm, H2: 3cm This is Suitable for RO-50G Series	HGP-126 L: 11.5cm, W: 6cm, H: 11cm This is Suitable for Housing 126

HG-0102A L: 13.5cm, W: 12.8cm, H1: 5cm, H2: 5cm This is Suitable for NW-1	HG-0203A L: 25cm, W: 12.8cm, H1: 4cm, H2: 3.2cm This is Suitable for NW-2	HG-0301A L: 36cm, W: 12.8cm, H1: 4cm, H2: 3.2cm This is Suitable for NW-3	ROG-0301L (White) L: 36cm, W: 17cm, H1: 14cm, H2: 3cm This is Suitable for RO-50G Series	LT-01 Faucet Bracket

HG-0303 L: 36cm, W: 12.8cm, H1: 4cm, H2: 3.5cm This is Suitable for US-3	DC-1 Dustproof Cover

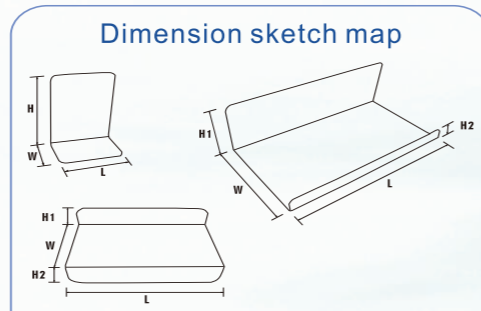

RO Quick Fittings

	FASTENER PART-NO. TUBE O.D DCC-001A 1/4 DCC-001B 3/8		RO Tube-1 1/4"		RO Tube-2 3/8"
	QUICK ADAPTER PART-NO. TUBE O.D DCC-001-1 1/4 DCC-001-2 3/8		"T" UNION TEE ADAPTER PART-NO. TUBE O.D THREAD TUBE O.D DCC-009A 1/4 1/4 1/4 DCC-009B 1/4 1/4 3/8 DCC-009C 1/4 3/8 1/4 DCC-009D 1/4 3/8 3/8 DCC-009E 3/8 3/8 3/8		"L" ELBOW FEMALE ADAPTER PART-NO. TUBE O.D THREAD DCC-018 1/4 1/4
	"L" MALE ELBOW ADAPTER PART-NO. TUBE O.D THREAD DCC-002A 1/4 1/4 DCC-002B 1/4 1/2 DCC-002C 3/8 1/4 DCC-002D 3/8 3/8 DCC-002E 3/8 1/2		"T" STEM/PING IN TEE ADAPTER PART-NO. TUBE O.D TUBE O.D STEM O.D DCC-010A 1/4 1/4 1/4 DCC-010D 3/8 3/8 3/8		STRAIGHT FEMALE ADAPTER PART-NO. TUBE O.D THREAD DCC-019A 1/4 1/4 DCC-019B 3/8 1/4 DCC-019C 3/8 3/8 DCC-019D 1/4 7/16-24 DCC-019E 1/4 1/2 DCC-019F 3/8 1/2
	"L" STEM/PING IN ELBOW ADAPTER PART-NO. TUBE O.D STEM O.D DCC-003A 1/4 1/4 DCC-003B 1/4 3/8 DCC-003C 3/8 1/4 DCC-003D 3/8 3/8		"- MALE STRAIGHT ADAPTER PART-NO. TUBE O.D THREAD DCC-011A 1/4 1/8		"L" CHECK VALVES ADAPTER PART-NO. TUBE O.D THREAD DCC-020A 1/4 1/8 DCC-020B 1/4 1/4
	"L" SHAPED TWO OPEN BENDER PART-NO. TUBE O.D TUBE O.D DCC-004A 1/4 1/4 DCC-004B 1/4 3/8 DCC-004C 3/8 3/8		"- MALE STRAIGHT ADAPTER PART-NO. TUBE O.D THREAD DCC-012A 1/4 1/4 DCC-012B 1/4 3/8 DCC-012C 3/8 3/8 DCC-012D 3/8 1/4 DCC-012E 1/4 1/2 DCC-012F 3/8 1/2		NPT90° BALL VALVE PART-NO. TUBE O.D THREAD DCC-024A 1/4 1/4 DCC-024B 1/4 3/8
	"L" MALE ELBOW ADAPTER PART-NO. TUBE O.D THREAD DCC-005A 1/4 3/8		HAND VALVE PART-NO. TUBE O.D THREAD DCC-025A 1/4 1/4 DCC-025B 3/8 3/8		SHUT-OFF PART-NO. TUBE O.D PRESSURE DIFFERENCE DCC-021 1/4x4 3kg±0.2
	"L" SHAPED TWO OPEN CONNECT PART-NO. TUBE O.D TUBE O.D DCC-006A 1/4 1/4 DCC-006B 1/4 3/8 DCC-006C 3/8 3/8		BULK HEAD ADAPTER PART-NO. TUBE O.D TUBE O.D THREAD DCC-014A 1/4 1/4 #16.5mm DCC-014B 1/4 3/8 #20mm DCC-014C 3/8 3/8 #20mm		HIGH PRESSURE PART-NO. TUBE O.D TUBE O.D Adjustable range of pressure DCC-023 1/4 1/4 2.0kg±4.5kg
	"T" MALE TEE ADAPTER PART-NO. TUBE O.D THREAD TUBE O.D DCC-007A 1/4 1/4 1/4 DCC-007B 1/4 3/8 1/4 DCC-007D 1/4 3/8 3/8 DCC-007E 3/8 3/8 3/8		LENGTHEN ADAPTER PART-NO. TUBE O.D THREAD DCC-015BB 1/4 1/4		LOW PRESSURE PART-NO. TUBE O.D TUBE O.D Start the pressure DCC-022 1/4 1/4 >0.3kg
	"T" MALE TEE ADAPTER PART-NO. TUBE O.D TUBE O.D THREAD DCC-008A 1/4 1/4 1/4 DCC-008C 1/4 3/8 3/8 DCC-008E 3/8 3/8 3/8 DCC-008G 3/8 3/8 1/4		"T" STEM/PING IN TEE ADAPTER PART-NO. TUBE O.D TUBE O.D STEM O.D DCC-028A 1/4 1/4 1/4 DCC-028D 3/8 3/8 3/8		STRAIGHT FEMALE ADAPTER PART-NO. TUBE O.D TUBE O.D DCC-020Y 1/4 1/4
	"T" MALE TEE ADAPTER PART-NO. TUBE O.D TUBE O.D TUBE O.D DCC-017A 1/4 1/4 1/4		"Y" TWO WAY SPLITTER PART-NO. TUBE O.D in TUBE O.D out TUBE O.D out DCC-017A 1/4 1/4 1/4		HAND VALVE PART-NO. TUBE O.D THREAD DCC-029A 1/4 1/4 DCC-029B 3/8 3/8
			RESTRICTOR PART-NO. TUBE O.D THREAD DCC-16Q 1/4 φ40mm		

Filter Components

VA-01	VA-02	VA-03	VA-08	FC-04
1/2", 3/8" Tube Diverter Valve	1/2", 3/8" Tube Diverter Valve	1/2", 3/8" Tube Diverter Valve	1/2" Diverter Valve	1/2", 1/2" or 3/4", 3/4" Diverter Connector

AVA-02Q	MV-01M	MV-02M	VA-09	VA-09B
1/4" Diverter Valve	1/4", 1/4" Chromed Mixing Valve	1/4" RO Tube, 1/4" RO Tube Chromed Mixing Valve	1/2", 3/4" Diverter Connector	1/2", 3/4" Diverter Connector

MF-02	MF-02A	MF-02B	MF-01	MF-02S	MF-03	MFV-01
3/4", 3/4", 1/4" Diverter Valve	3/8", 3/8", 1/4" Diverter Valve	3/4", 3/4", 1/4" Diverter Valve	1/2", 1/2", 1/4" Diverter Valve	3/8", 3/8", 1/4" Diverter Valve	3/4", 1/4" Diverter Valve	1/2", 1/2", 1/4" Diverter Valve

MFV-02	CT-01	CT-02	CT-03	PRV-2	PRV-3
1/4", 1/2", 1/4" Tube Diverter Valve	1/4", 3/8" Tube Metal Connector	1/4", 3/8" Tube Metal Connector	1/4", 3/8" Tube Metal Connector	1/4", 1/4" Tube Pressure Reduce Valve	1/4", 1/4" Tube Pressure Reduce Valve (Quick Fitting)

Filter Components

PSH-700	PSH-800	FL-505	FL-506	FL-507	ASV-408
High Pressure Switch	Low Pressure Switch	Float Switch	Float Switch	Float Switch	Auto Shut-Off Valve

VA-05	VA-06	TR-420-2	SVA-824	SVA-825
Feed Water Valve 1/4" Outer Pitch 1/4" Inner Pipe	Feed Water Valve 1/4" Outer Pitch 3/8" Inner Pipe	Water Electrolyzer	Solenoid Valve	Solenoid Valve

SVA-827-1	SVA-827-2	SVA-827-3	SVA-826-1	SVA-826-2
1/8" Solenoid Valve	1/4" Solenoid Valve	Solenoid Valve With Flow-Limit Valve	Auto Flush Solenoid Valve	Auto Flush Solenoid Valve With Flow-Limit Valve

CB-1	CB-2	CB-3	CB-4	CB-5
Lamp Indicator IC Controller	LCD IC Controller	Digital IC Controller	Digital TDS IC Controller	LCD IC Controller

TF-450M TF-300M TF-1200M	LP-1	CLM-5	SL-07	TRG-3
Metal Flow - Limit Insert	Leakage Protection	Drain Clamp	Valve Base Groupware	Pump Diaphragms

TF-450 TF-300	TDS-3	ST-1
Plastic Flow - Limit Valve	TDS Meter	Seal Tape

Detector



Model : HZ-JCX

Packing Dimension : 240x240x60mm

Serial Number	Tool Name	Qty
1	TDA-3 Water quality detecting pen	1
2	Water electrolysis device	1
3	BIO Mineral conductive pen	1
4	PH reagent	4
5	Residual chlorine reagent	4
6	Calmagite reagent	2
7	Zinc reagent	2
8	Mineral reagent	1
9	Antioxidant reagent	1
10	Bleach water	1
11	Phenolphthalein reagent	1
12	Red pigment(10g)	1
13	Industrial pollution	1
14	Small plastic tool box	1

Industrial Equipments



Provide Best Designs, Solutions & Equipment for Any Water



For more details, Please refer to our industrial edition

